

DISTRIBUTION

Miniature Circuit Breakers BE1 Series



BE1 Series Miniature Circuit Breaker

Features

This series of miniature circuit breaker is for the purpose of the protection of distribution equipment in the residential or similar facility, to protect against short circuit and overload damage.

- Among the characteristics of overload protection, there are the Curve C characteristic for the protection of lighting electrical systems having $5 \sim 10I_n$ instantaneous tripping characteristic, and the Curve D characteristic for the protection of ordinary electrical system wires having $10 \sim 14I_n$ instantaneous tripping characteristic.
- ELCB is completed by combining a miniature circuit breaker with an earth leakage shunt trip device.
- As functional components can be installed such as auxiliary switch, alarm switch among others, it can monitor and control the electrical system.

Product Composition

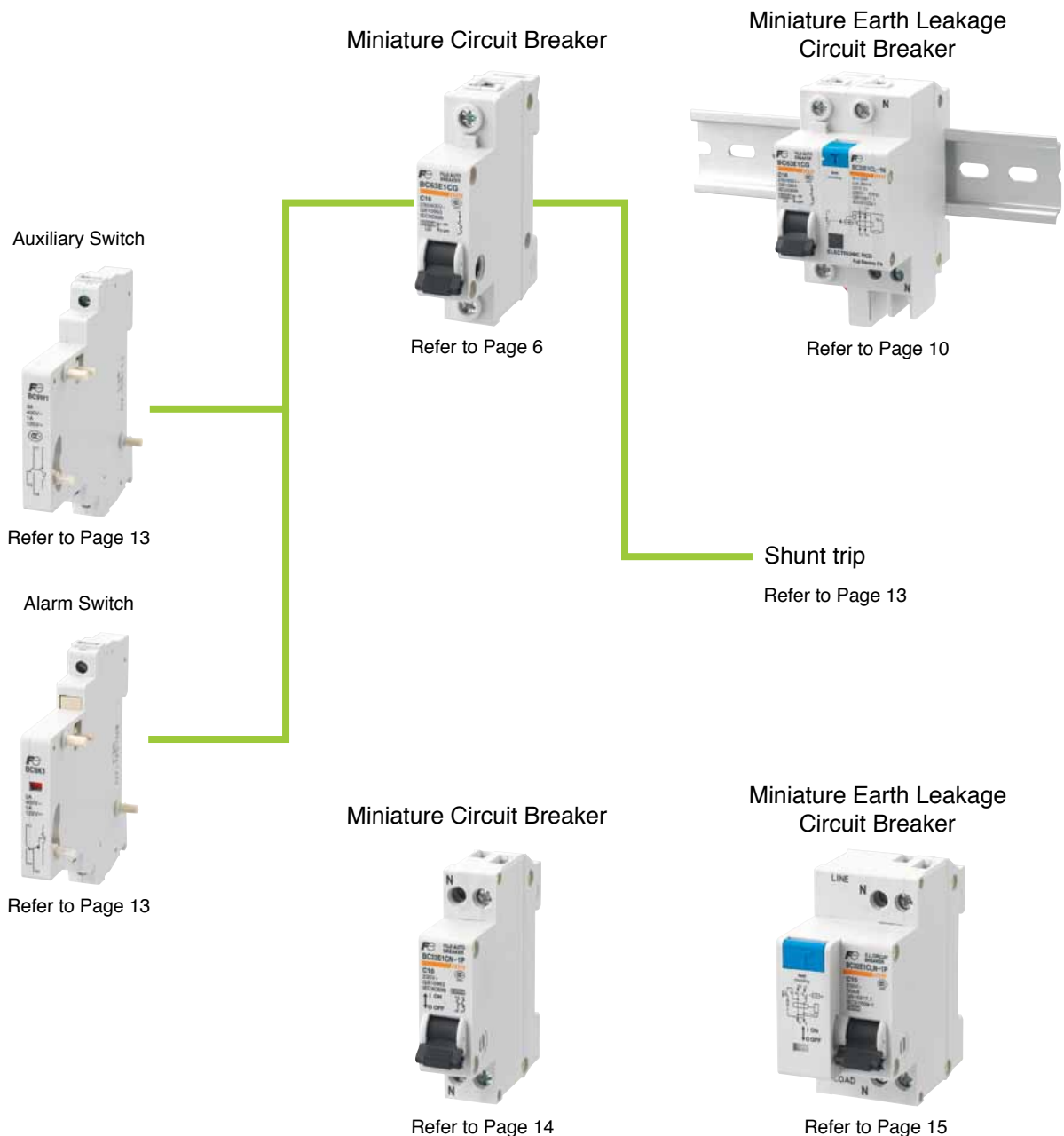

Catalog Disclaimer

The information contained in this catalog does not constitute an express or implied warranty of quality, any warranty of merchantability of fitness for a particular purpose is hereby disclaimed.

Since the user's product information, specific use application, and conditions of use are all outside of Fuji Electric FA Components & Systems' control, **it shall be the responsibility of the user to determine the suitability of any of the products mentioned for the user's application.**

One Year Limited Warranty

The products identified in this catalog shall be sold pursuant to the terms and conditions identified in the "Conditions of Sale" issued by Fuji Electric FA with each order confirmation.

Except to the extent otherwise provided for in the Conditions of Sale issued by Fuji Electric FA, Fuji Electric FA warrants that the Fuji Electric FA products identified in this catalog shall be free from significant defects in materials and workmanship provided the product has not been: 1) repaired or altered by others than Fuji Electric FA; 2) subjected to negligence, accident, misuse, or damage by circumstances beyond Fuji Electric FA's control; 3) improperly operated, maintained or stored; or 4) used in other than normal use or service. This warranty shall apply only to defects appearing within one (1) year from the date of shipment by Fuji Electric FA, and in such case, only if such defects are reported to Fuji Electric FA within thirty (30) days of discovery by purchaser. Such notice should be submitted in writing to Fuji Electric FA at 5-7, Nihonbashi Odemma-cho, Chuo-ku, Tokyo, Japan. The sole and exclusive remedy with respect to the above warranty whether such claim is based on warranty, contract, negligence, strict liability or any other theory, is limited to the repair or replacement of such product or, at Fuji Electric FA's option reimbursement by Fuji Electric FA of the purchase price paid to Fuji Electric FA for the particular product. **Fuji Electric FA does not make any other representations or warranties, whether oral or in writing, expressed or implied, including but not limited to any warranty regarding merchantability or fitness for a particular purpose.** Except as provided in the Conditions of Sale, no agent or representative of Fuji Electric FA is authorized to modify the terms of this warranty in writing or orally.

In no event shall Fuji Electric FA be liable for special, indirect or consequential damages, including but not limited to, loss of use of the product, other equipment, plant and power system which is installed with the product, loss of profits or revenues, cost of capital, or claims against the purchaser or user of the product by its customers resulting from the use of information, recommendations and descriptions contained herein. The purchaser agrees to pass on to its customers and users, in writing at the time inquiries and orders are received by buyer, Fuji Electric FA's warranty as set forth above.

BE1 Series Miniature Circuit Breakers

BC63 Series Miniature Circuits Breaker-----	6
BC32 and BC50 Series Miniature Earth Leakage Circuit Breaker -----	10
Optional Accessories -----	13
BC32 Series Miniature Circuit Breaker (1P+N)-----	14
BC32 Series Miniature Earth Leakage Circuit Breaker (1P+N) -----	15
Wiring Method -----	16
Characteristic Curves-----	16
Temperature Compensation Table-----	17



BE1 Series Miniature Circuit Breakers

BC63 Series

■ BC63 Series Miniature Circuit Breaker Standards

● Application

- Curve C: Illumination distribution system
Curve D: Industrial distribution system
- Overload and short circuit protection

● Type number nomenclature

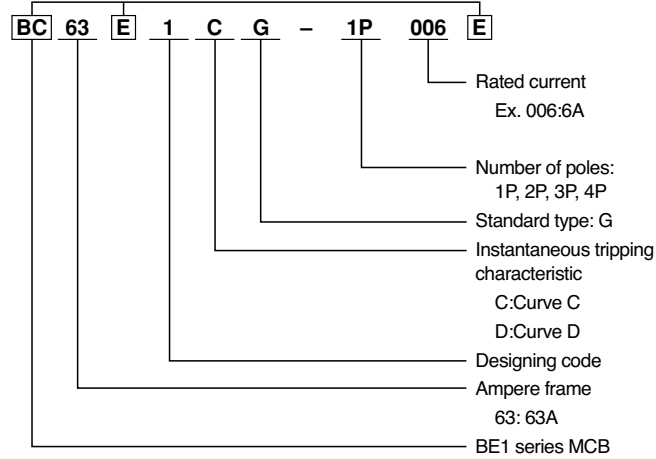

● Standards and Certificates

- IEC 60898-1, GB 10963.1
- CE, CCC

● Working Condition

- Ambient temperature: -35°C to +70°C
- Altitude: ≤2000m
- Air humidity: ≤95%
- Pollution degree: II
- A place where there should not be significant shock or vibration

● Product Features

- With short circuit current limiting structure-high breaking capacity of lated short circuit.
- Short-circuit and overload protection
- Screw clamp, shock-proof wiring terminals
- Numerous accessories available
- Modularization-random combination, series mating
- Standard TH35 mm IEC rail mounting

● Specifications

- Rated voltage: AC230/400V, 50/60Hz
- Rated current: page 5-6
- Mechanical life: 10000 times
- Tripping characteristic: C: 5~10I_n
D: 10-14I_n
- Breaking capacity

Tripping characteristic	Rated current (A)	Rated operational voltage (V)	Rated breaking capacity (kA)
Curve C	1~40	230/400	6
	50, 63	230/400	4.5
Curve D	1~40	230/400	4.5

● Wiring Capacity

Rated current (A)	Wire size (mm ²)
I _n ≤63	25

● Dimensions, mm

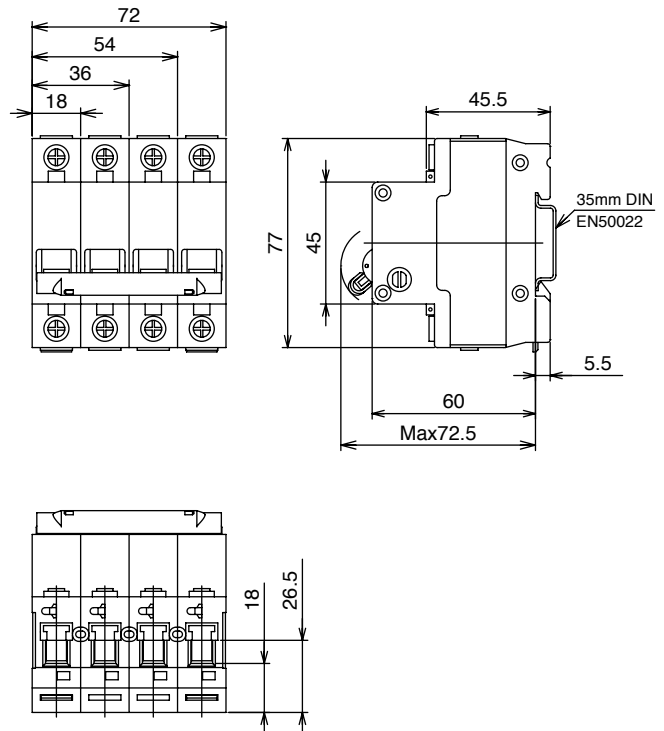

BE1 Series Miniature Circuit Breakers BC63 Series

● Type and Rated Current



1P



Number of poles	Tripping characteristics	Width (mm)	Rated current (A)	Type
1P	Curve C	18	1	BC63E1CG-1P001E
			2	BC63E1CG-1P002E
			3	BC63E1CG-1P003E
			4	BC63E1CG-1P004E
			5	BC63E1CG-1P005E
			6	BC63E1CG-1P006E
			10	BC63E1CG-1P010E
			16	BC63E1CG-1P016E
			20	BC63E1CG-1P020E
			25	BC63E1CG-1P025E
			32	BC63E1CG-1P032E
			40	BC63E1CG-1P040E
	50	BC63E1CG-1P050E		
	63	BC63E1CG-1P063E		
	Curve D	18	1	BC63E1DG-1P001E
			2	BC63E1DG-1P002E
			3	BC63E1DG-1P003E
			4	BC63E1DG-1P004E
			5	BC63E1DG-1P005E
			6	BC63E1DG-1P006E
			10	BC63E1DG-1P010E
			16	BC63E1DG-1P016E
			20	BC63E1DG-1P020E
			25	BC63E1DG-1P025E
32			BC63E1DG-1P032E	
40			BC63E1DG-1P040E	
2P	Curve C	36	1	BC63E1CG-2P001E
			2	BC63E1CG-2P002E
			3	BC63E1CG-2P003E
			4	BC63E1CG-2P004E
			5	BC63E1CG-2P005E
			6	BC63E1CG-2P006E
			10	BC63E1CG-2P010E
			16	BC63E1CG-2P016E
			20	BC63E1CG-2P020E
			25	BC63E1CG-2P025E
			32	BC63E1CG-2P032E
			40	BC63E1CG-2P040E
	50	BC63E1CG-2P050E		
	63	BC63E1CG-2P063E		
	Curve D	36	1	BC63E1DG-2P001E
			2	BC63E1DG-2P002E
			3	BC63E1DG-2P003E
			4	BC63E1DG-2P004E
			5	BC63E1DG-2P005E
			6	BC63E1DG-2P006E
			10	BC63E1DG-2P010E
			16	BC63E1DG-2P016E
			20	BC63E1DG-2P020E
			25	BC63E1DG-2P025E
32			BC63E1DG-2P032E	
40			BC63E1DG-2P040E	



2P

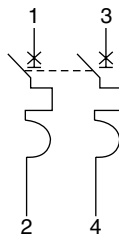

BE1 Series Miniature Circuit Breakers

BC63 Series

● Type and Rated Current

Number of poles	Tripping characteristics	Width (mm)	Rated current (A)	Type
3P	Curve C	54	1	BC63E1CG-3P001E
			2	BC63E1CG-3P002E
			3	BC63E1CG-3P003E
			4	BC63E1CG-3P004E
			5	BC63E1CG-3P005E
			6	BC63E1CG-3P006E
			10	BC63E1CG-3P010E
			16	BC63E1CG-3P016E
			20	BC63E1CG-3P020E
			25	BC63E1CG-3P025E
			32	BC63E1CG-3P032E
			40	BC63E1CG-3P040E
			50	BC63E1CG-3P050E
			63	BC63E1CG-3P063E
	Curve D		1	BC63E1DG-3P001E
			2	BC63E1DG-3P002E
			3	BC63E1DG-3P003E
			4	BC63E1DG-3P004E
			5	BC63E1DG-3P005E
			6	BC63E1DG-3P006E
			10	BC63E1DG-3P010E
			16	BC63E1DG-3P016E
			20	BC63E1DG-3P020E
			25	BC63E1DG-3P025E
			32	BC63E1DG-3P032E
			40	BC63E1DG-3P040E
4P	Curve C	72	1	BC63E1CG-4P001E
			2	BC63E1CG-4P002E
			3	BC63E1CG-4P003E
			4	BC63E1CG-4P004E
			5	BC63E1CG-4P005E
			6	BC63E1CG-4P006E
			10	BC63E1CG-4P010E
			16	BC63E1CG-4P016E
			20	BC63E1CG-4P020E
			25	BC63E1CG-4P025E
			32	BC63E1CG-4P032E
			40	BC63E1CG-4P040E
			50	BC63E1CG-4P050E
			63	BC63E1CG-4P063E
	Curve D		1	BC63E1DG-4P001E
			2	BC63E1DG-4P002E
			3	BC63E1DG-4P003E
			4	BC63E1DG-4P004E
			5	BC63E1DG-4P005E
			6	BC63E1DG-4P006E
			10	BC63E1DG-4P010E
			16	BC63E1DG-4P016E
			20	BC63E1DG-4P020E
			25	BC63E1DG-4P025E
			32	BC63E1DG-4P032E
			40	BC63E1DG-4P040E

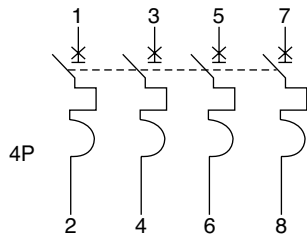
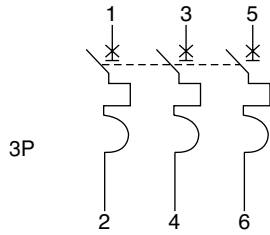

● Precautions for the DC use of BC63 Series Miniature Circuit Breaker

- Choose the rated current of the circuit breaker according to the power of direct current circuit.
- DC rated voltage determines the number of cascades of circuit breaker to use.
 - DC60V One pole
 - DC125V Two poles
 - DC250V Four poles
- Such use does not have to be divided into positive and negative and can be up and down into the line.
- In the above use condition, the estimated short circuit current cannot exceed its rated service short circuit breaking capacity.

Circuit breaker model	Rated current (A)	DC rated service short circuit breaking capacity (kA)		
		60V	125V	250V
BC63	1A~63A	10(1P)	20(2P)	50(4P)

● Wiring Schematics

Ex. 1

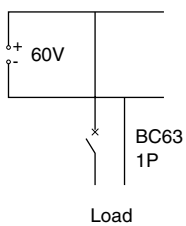

Ex. 2

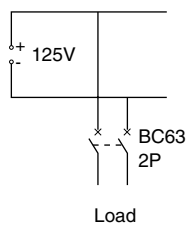

Ex. 3

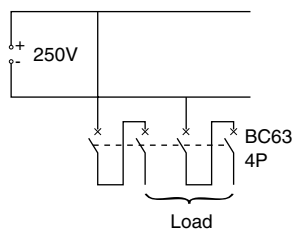

BE1 Series Miniature Circuit Breakers BC32 and BC50 Series

■ Miniature Earth Leakage Circuit Breaker Standards

● Application

- Clip onto the right side of BC32E1, BC50E1 series MCB protection against earth leakage faults.

● Type number nomenclature

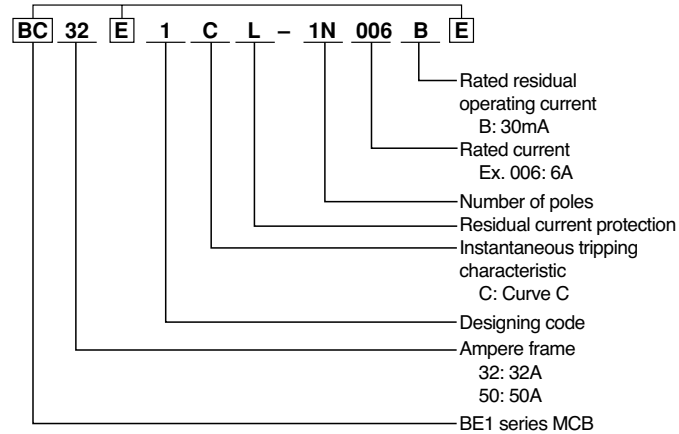

● Appearance



● Wiring Capacity

Rated current (A)	Wire size (mm ²)	
	Power	Load
$I_n \leq 32$	25	10
$I_n \leq 50$		25

● Standards and Certificates

- IEC 61009-1, GB 16917.1
- CCC

● Working Condition

- Ambient temperature: -5°C to +40°C
- Altitude: $\leq 2000\text{m}$
- Air humidity: $\leq 95\%$
- Pollution degree: II
- A place where there should not be significant shock or vibration

● Specifications

- Rated voltage: AC230/400V(1PN, 2P) 50Hz
AC400V(3P, 3PN, 4P) 50Hz
- Rated current: page 10
- Rated residual operating current: 30mA
- Mechanical life: 20000 times
- Instantaneous tripping characteristic: curve C: 5-10I_n
- Breaking capacity

Tripping characteristic	Rated current (A)	Rated operational voltage (V)	Rated breaking capacity (kA)
Curve C	1~40	230/400	6
	50	230/400	4.5

BE1 Series Miniature Circuit Breakers BC32 and BC50 Series

● Dimensions, Miniature Earth Leakage Circuit Breaker, mm

Miniature earth leakage circuit breaker consists of miniature circuit breaker and earth leakage shunt trip.

BC32E1CL

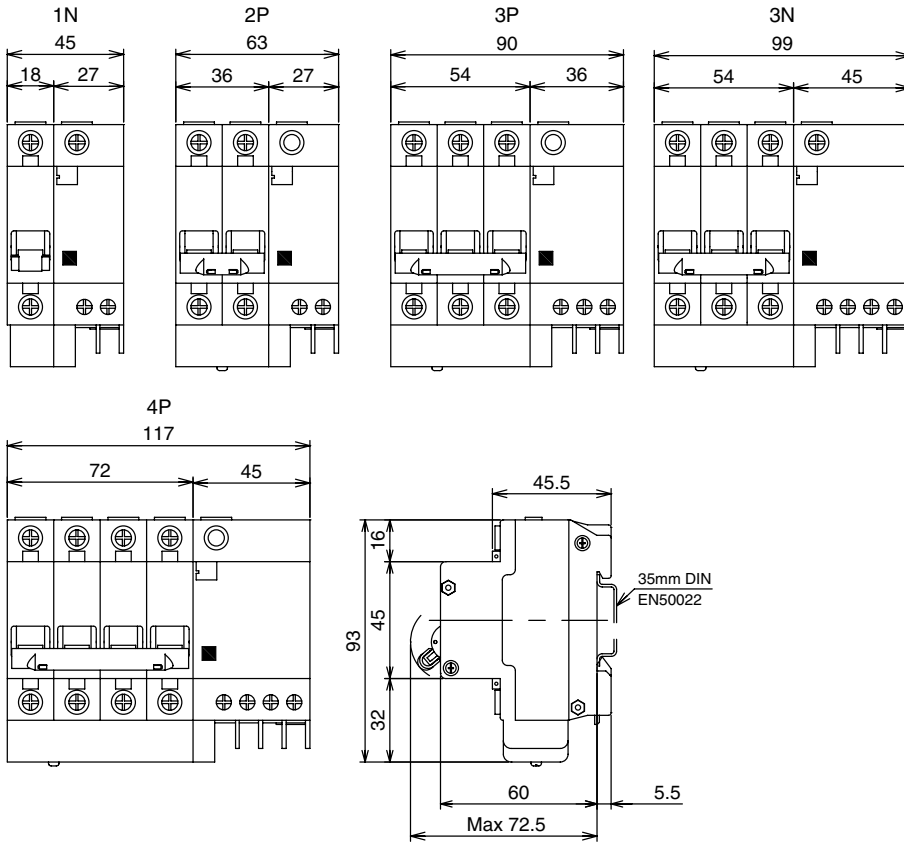

BC50E1CL

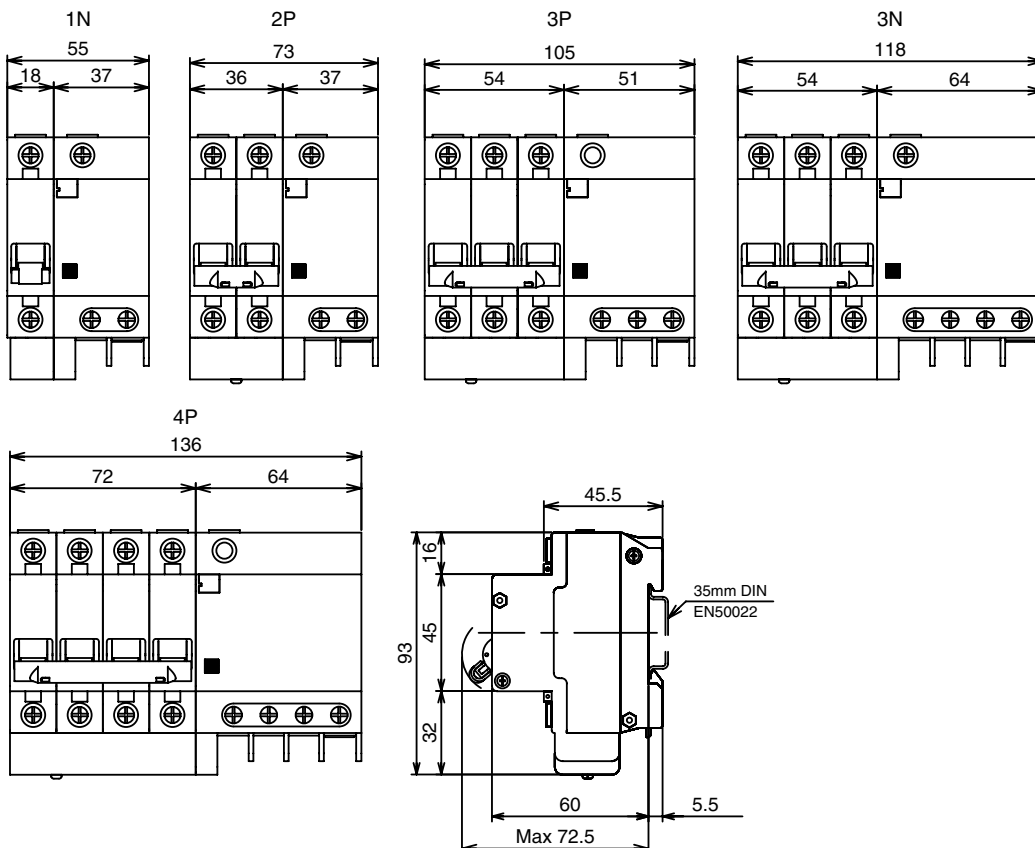

BE1 Series Miniature Circuit Breakers BC32 and BC50 Series

● Type and Rated Current

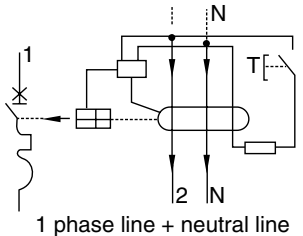
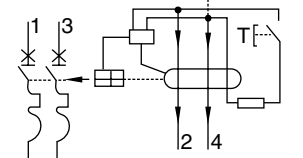
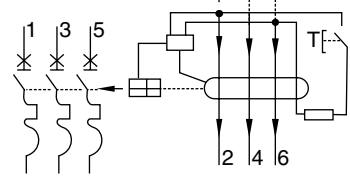
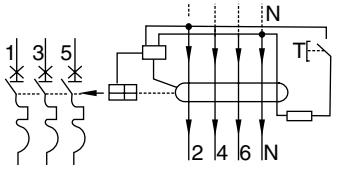
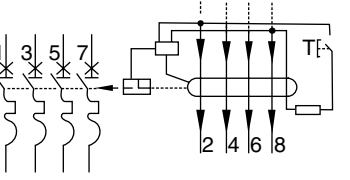
Number of poles	Wiring diagram	Tripping characteristics	Width (mm)		Rated current (A)	Type
			Miniature circuit breaker	Earth leakage shunt trip		
1N	 <p>1 phase line + neutral line</p>	Curve C	18	27	1	BC32E1CL-1N001BE
					2	BC32E1CL-1N002BE
					3	BC32E1CL-1N003BE
					4	BC32E1CL-1N004BE
					5	BC32E1CL-1N005BE
					6	BC32E1CL-1N006BE
			32	10	BC32E1CL-1N010BE	
				16	BC32E1CL-1N016BE	
				20	BC32E1CL-1N020BE	
				25	BC32E1CL-1N025BE	
				32	BC32E1CL-1N032BE	
				37	40	BC50E1CL-1N040BE
					50	BC50E1CL-1N050BE
2P		Curve C	36	27	1	BC32E1CL-2P001BE
					2	BC32E1CL-2P002BE
					3	BC32E1CL-2P003BE
					4	BC32E1CL-2P004BE
					5	BC32E1CL-2P005BE
					6	BC32E1CL-2P006BE
			32	10	BC32E1CL-2P010BE	
				16	BC32E1CL-2P016BE	
				20	BC32E1CL-2P020BE	
				25	BC32E1CL-2P025BE	
				32	BC32E1CL-2P032BE	
				37	40	BC50E1CL-2P040BE
					50	BC50E1CL-2P050BE
3P		Curve C	54	36	1	BC32E1CL-3P001BE
					2	BC32E1CL-3P002BE
					3	BC32E1CL-3P003BE
					4	BC32E1CL-3P004BE
					5	BC32E1CL-3P005BE
					6	BC32E1CL-3P006BE
			32	10	BC32E1CL-3P010BE	
				16	BC32E1CL-3P016BE	
				20	BC32E1CL-3P020BE	
				25	BC32E1CL-3P025BE	
				32	BC32E1CL-3P032BE	
				51	40	BC50E1CL-3P040BE
					50	BC50E1CL-3P050BE
3N	 <p>3 phase line + neutral line</p>	Curve C	54	45	1	BC32E1CL-3N001BE
					2	BC32E1CL-3N002BE
					3	BC32E1CL-3N003BE
					4	BC32E1CL-3N004BE
					5	BC32E1CL-3N005BE
					6	BC32E1CL-3N006BE
			32	10	BC32E1CL-3N010BE	
				16	BC32E1CL-3N016BE	
				20	BC32E1CL-3N020BE	
				25	BC32E1CL-3N025BE	
				32	BC32E1CL-3N032BE	
				64	40	BC50E1CL-3N040BE
					50	BC50E1CL-3N050BE
4P		Curve C	72	45	1	BC32E1CL-4P001BE
					2	BC32E1CL-4P002BE
					3	BC32E1CL-4P003BE
					4	BC32E1CL-4P004BE
					5	BC32E1CL-4P005BE
					6	BC32E1CL-4P006BE
			32	10	BC32E1CL-4P010BE	
				16	BC32E1CL-4P016BE	
				20	BC32E1CL-4P020BE	
				25	BC32E1CL-4P025BE	
				32	BC32E1CL-4P032BE	
				64	40	BC50E1CL-4P040BE
					50	BC50E1CL-4P050BE

• The earth leakage shunt trip of our company is only supplied in conjunction with the miniature circuit breaker of our company and will not be supplied alone.

■ Accessories Standards

● Auxiliary switch (W) Type: BC9W1SA1-E

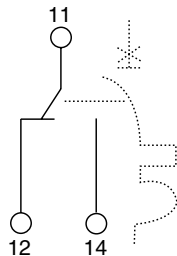

Application

- Linked to the left side of BC63 series MCB to indicate the OPEN or CLOSED status of the associated breaker

Specifications

- Rated operating parameters

Voltage	Current	Voltage	Current
AC 230V	6A	AC 400V	3A
DC 24V	6A	DC 48V	2A
DC 125V	1A	DC 250V	0.4A

- Width (mm): 9

Notes:

After clipping on to BC63

Point 11 and 14 are connected when circuit is closed;

Point 11 and 12 are connected when circuit is open.

May be used in conjunction with two alarm switches or another auxiliary switch.

● Alarm Switch (K) Type: BC9K1SA1-E

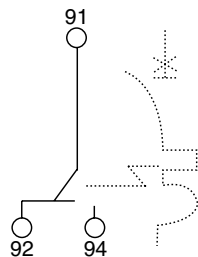

Application

- Linked to the left side of BC63 series MCB, to indicate the OPEN or CLOSED status of the associated breaker

Specifications

- Rated operating parameters

Voltage	Current	Voltage	Current
AC 230V	6A	AC 400V	3A
DC 24V	6A	DC 48V	2A
DC 125V	1A	DC 250V	0.4A

- Width (mm): 9

Notes:

After clipping on to BC63 MCB,

Point 91 and 92 are connected when circuit is closed;

Point 91 and 94 are connected when the breaker trips due to fault;

Point 91 and 92 are connected when the breaker trips by manual operation. Meanwhile, point 91 and 94 are disconnected.

May be used in conjunction with two alarm switches.

● Shunt trip (F+W) Type: BC9FRA1-E, BC9FKA1-E

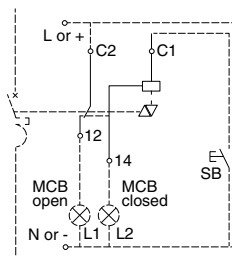

Application

- Linked to the right side of BC63 series MCB
- Remote control

Specifications

- Control voltage

Type	Control voltage
BC9FRA1-E	AC230/400V
BC9FKA1-E	DC24/48V

- Width (mm): 18

■ Standards and Certificates

- IEC 60947-5, GB 14048.5
- CCC

■ Wiring Capacity

- Single line: 2.5 mm² Double line: 1.5 mm²

■ Assembly methods

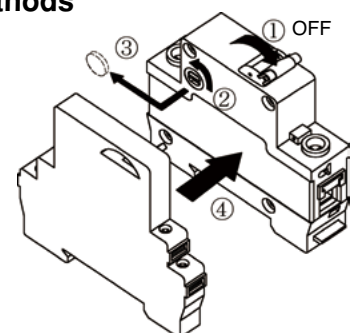

BE1 Series Miniature Circuit Breakers

BC32 Series Miniature Circuit Breaker (1P+N)

■ Miniature Circuit Breaker (1P+N)

● Application

- TT/TN-S grounding system
- Phase and neutral protection against short circuit and overload

● Type number nomenclature

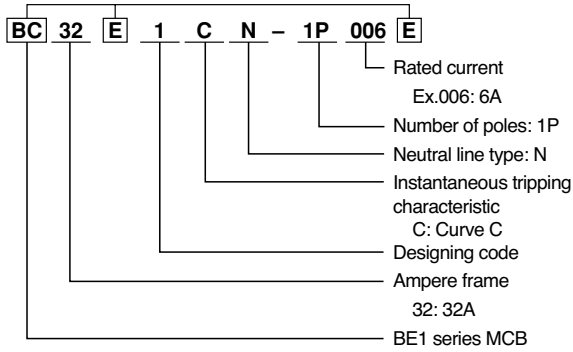

● Specifications

- Rated voltage: AC230V, 50/60Hz
- Mechanical life: 10000 times
- Tripping characteristic: C: 5~10I_n
- Breaking capacity: 4.5kA

● Wiring Capacity

- ≤ 10 mm²

● Dimensions, mm

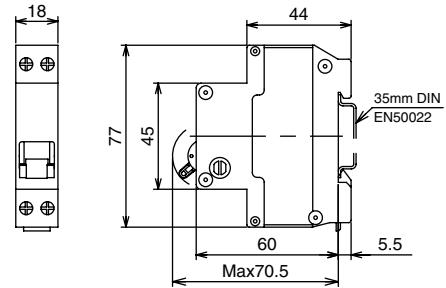

● Standards and Certificates

- IEC 60898-1, GB 10963.1
- CCC

● Working Condition

- Ambient temperature: -35°C to +70°C
- Altitude: ≤2000m
- Air humidity: ≤95%

● Product Features

- Phase and neutral are both switched when circuit opens or trips because of failure
- Neutral line connected early and disconnected late
- Screw clamp, shock-proof wiring terminals
- Standard TH35 mm IEC rail mounting

● Type and Rated Current



Number of poles	Width (mm)	Rated current (A)	Type
	18	6	BC32E1CN-1P006E
		10	BC32E1CN-1P010E
		16	BC32E1CN-1P016E
		20	BC32E1CN-1P020E
		25	BC32E1CN-1P025E
		32	BC32E1CN-1P032E

BE1 Series Miniature Circuit Breakers

BC32 Series Miniature Earth Leakage Circuit Breaker (1P+N)

■ Earth Leakage Circuit Breaker (1P+N)

● Application

- TT/TN-S grounding system
- Phase and neutral protection against short circuit and overload

● Type number nomenclature

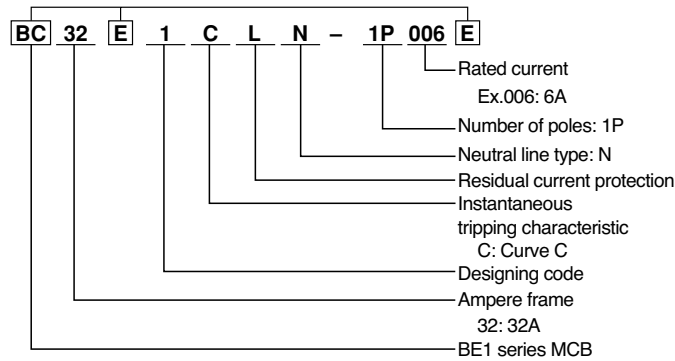

● Specifications

- Rated voltage: AC230V, 50Hz
- Mechanical life: 10000 times
- Tripping characteristic: C: 5~10In
- Rated residual operating current: 30mA
- Breaking capacity: 4.5kA

● Wiring Capacity

- $\leq 10 \text{ mm}^2$

● Dimensions, mm

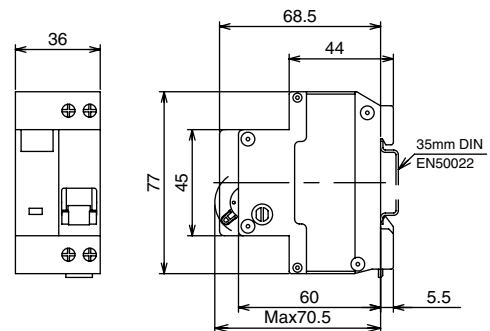

● Standards and Certificates

- IEC 61009-1, GB 16917.1
- CCC

● Working Condition

- Ambient temperature: -5°C to $+40^{\circ}\text{C}$
- Altitude: $\leq 2000\text{m}$
- Air humidity: $\leq 95\%$

● Product Features

- Phase and neutral are both switched when circuit opens or trips because of failure
- Neutral line connected early and disconnected late
- Convenient wiring
- Standard TH35 mm IEC rail mounting

● Type and Rated Current



Number of poles	Width (mm)	Rated current (A)	Rated residual operating current (mA)	Type
	36	6	30	BC32E1CLN-1P006E
		10		BC32E1CLN-1P010E
		16		BC32E1CLN-1P016E
		20		BC32E1CLN-1P020E
		25		BC32E1CLN-1P025E
		32		BC32E1CLN-1P032E

BE1 Series Miniature Circuit Breakers

Wiring Method/Characteristic Curves

■ Wiring Method

● Use of phase line and neutral line series products in the TT / TN-S systems

Phase line and neutral line are required to be switched in the TT (three-phase four-wire system)/TN-S (three-phase five-wire system) systems.

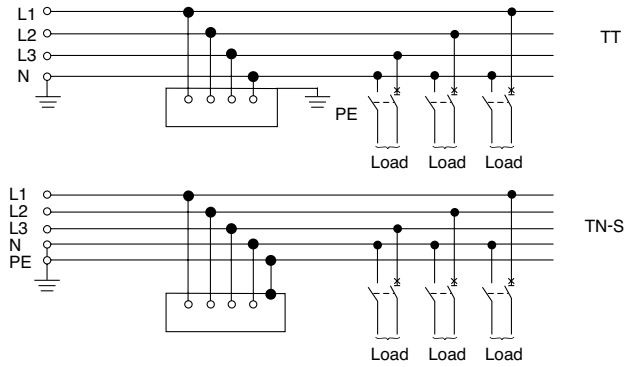

■ Characteristic Curves

● BC32, BC50, BC63

• Curve C (5~10I_n)

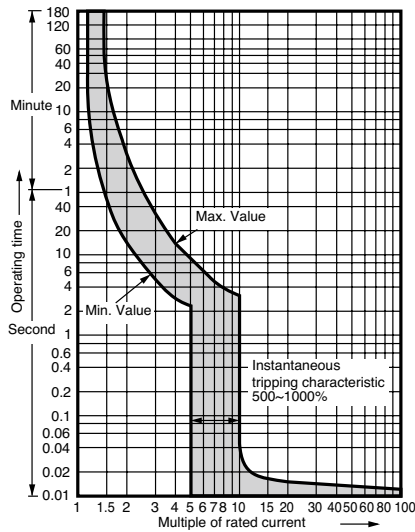

• Curve D (10~14I_n)

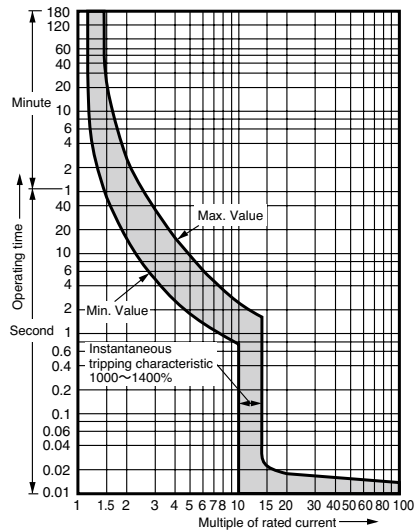

BE1 Series Miniature Circuit Breakers Temperature Compensation Table

■ Temperature Compensation Table

Compensated current(A)		Rated current(A)										
		1	3	6	10	16	20	25	32	40	50	63
Ambient temperature (C°)	-35	1.27	3.89	7.70	13.89	20.78	25.67	32.21	41.04	51.63	64.92	83.48
	-30	1.25	3.83	7.58	13.62	20.43	25.28	31.72	40.46	50.86	63.97	82.06
	-25	1.23	3.76	7.46	13.35	20.08	24.88	31.22	39.82	50.04	62.92	80.64
	-20	1.21	3.70	7.34	13.07	19.75	24.47	30.70	39.17	49.21	61.86	79.19
	-15	1.19	3.64	7.21	12.81	19.40	24.06	30.18	38.51	48.37	60.77	77.72
	-10	1.17	3.57	7.09	12.53	19.05	23.64	29.65	37.84	47.51	59.67	76.22
	-5	1.15	3.50	6.96	12.23	18.70	23.22	29.10	37.15	46.63	58.54	74.70
	0	1.13	3.44	6.83	11.93	18.33	22.78	28.55	36.47	45.74	57.40	73.14
	5	1.10	3.37	6.70	11.63	17.96	22.34	27.98	35.75	44.83	56.23	71.54
	10	1.08	3.30	6.56	11.33	17.58	21.89	27.41	35.03	43.90	55.05	69.91
	15	1.06	3.22	6.42	11.01	17.20	21.43	26.82	34.30	42.95	53.81	68.24
	20	1.05	3.14	6.27	10.67	16.80	20.96	26.22	33.54	41.98	52.56	66.53
	25	1.02	3.06	6.14	10.34	16.40	20.47	25.61	32.77	40.99	51.28	64.78
	30	1.00	3.00	6.00	10.00	16.00	20.00	25.00	32.00	40.00	50.00	63.00
	35	0.97	2.92	5.84	9.63	15.35	19.47	24.33	31.17	38.93	47.82	60.11
	40	0.94	2.84	5.68	9.24	15.11	18.95	23.67	30.34	37.85	46.24	58.19
	45	0.91	2.76	5.52	8.85	14.66	18.42	23.00	29.48	36.75	44.81	56.21
	50	0.89	2.67	5.36	8.45	14.20	17.87	22.28	28.60	35.61	43.33	54.16
	55	0.86	2.58	5.19	8.01	13.71	17.30	21.56	27.69	34.43	41.81	52.03
60	0.83	2.49	5.01	7.55	13.21	16.71	20.80	26.75	33.21	40.23	49.81	
65	0.80	2.38	4.83	7.06	12.70	16.10	20.02	25.78	31.95	38.58	47.50	
70	0.77	2.27	4.64	6.55	12.15	15.47	19.21	24.77	30.63	35.77	43.05	

Note: Ambient temperature means the set temperature within the circuit breaker distribution box or distribution panel.
The standard ambient temperature of 1A-63A circuit breaker is 30°C.

Memo

Safety Considerations

- Operate (keep) in the environment specified in the operating instructions and manual. High temperature, high humidity, condensation, dust, corrosive gases, oil, organic solvents, excessive vibration or shock might cause electric shock, fire, erratic operation or failure.
- For safe operation, before using the product read the instruction manual or user manual that comes with the product carefully or consult the Fuji sales representative from which you purchased the product.
- Products introduced in this catalog have not been designed or manufactured for such applications in a system or equipment that will affect human bodies or lives.
- Customers, who want to use the products introduced in this catalog for special systems or devices such as for atomic-energy control, aerospace use, medical use, passenger vehicle, and traffic control, are requested to consult with Fuji Electric FA.
- Customers are requested to prepare safety measures when they apply the products introduced in this catalog to such systems or facilities that will affect human lives or cause severe damage to property if the products become faulty.
- For safe operation, wiring should be conducted only by qualified engineers who have sufficient technical knowledge about electrical work or wiring.
- Follow the regulations of industrial wastes when the product is to be discarded.
- For further questions, please contact your Fuji sales representative or Fuji Electric FA.

 **Fuji Electric FA Components & Systems Co., Ltd.**

5-7, Nihonbashi Odemma-cho, Chuo-ku, Tokyo, 103-0011, Japan

URL <http://www.fujielectric.co.jp/fcs/eng>