



Architect: ODA  
Photo: Lester Ali

## SLIMLINE 38

Light, elegance, and comfort



Reynaers  
Aluminium

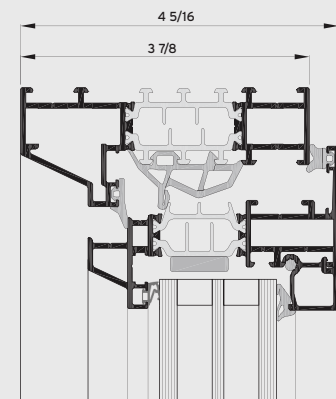
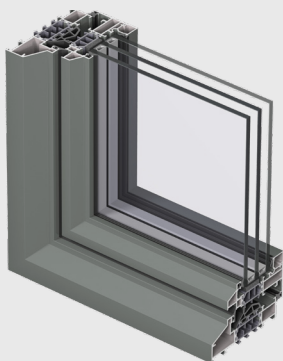

SlimLine 38 is a highly insulated system with inward and outward opening windows and doors, which combines elegance and comfort amidst a unique design. SL 38 is available in 3 different minimalistic design variants, Classic, Ferro, and Cubic, to perfectly match the architectural aspect of the building. The windows and doors can accommodate double and triple glazing without losing the ultra-slim look.

In combination with its superior insulation capabilities, the system provides the perfect harmony between durable material, clean design, and demanding architectural challenges.





### SL 38 DOORS

This special slender steel look is the perfect solution for modern architecture and renovation of steel-framed windows, respecting the original design but offering a thermally improved solution.

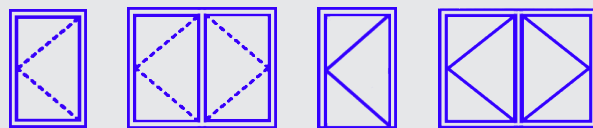

### SL 38 WINDOWS

Mix multi-pane units that are comprised of fixed and operable vents that are both inward and outward opening for a synergy between open views, ventilation and design essence.

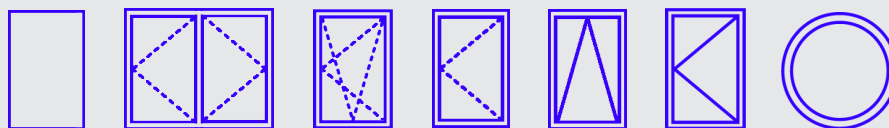

## CLASSIC

A slender steel look combining elegance and comfort while featuring a classic design with narrow sightlines.

## FERRO

A Bauhaus style design mimicking the design of traditional steel windows and doors, adding a flare to typical modern design lines with a vent reveal for a unique look.

## CUBIC

A cubistic appearance mixing a slim look and sleek modern design geometry with common language to the functional profiles featured throughout other systems.

Windows

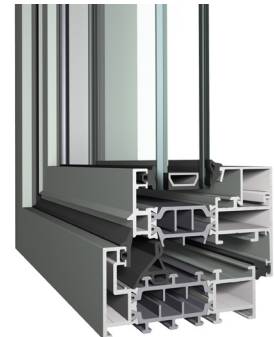
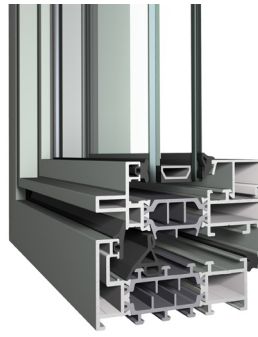
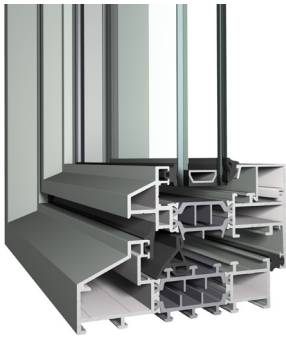



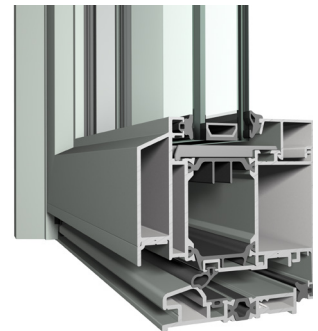
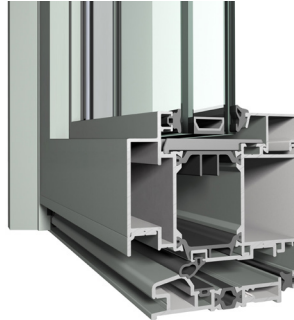
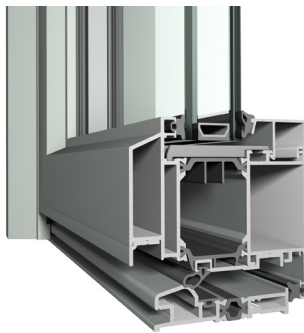

Doors



### TECHNICAL CHARACTERISTICS

Style variants		CLASSIC	CUBIC	FERRO
Min. visible width inward opening window	Frame	1 5/16"	1 5/16"	1 5/16"
	Vent	7/8"	7/8"	7/8"
Min. visible width outward opening window	Frame	1 1/8"	-	3/4"
	Vent	2 3/8"	-	2 3/8"
Min. visible width inward opening window-door	Frame	1 5/16"	1 5/16"	2 5/16"
	Vent	2 1/16"	2 1/16"	2 1/16"
Min. visible width outward opening window-door	Frame	1 1/8"	-	3/4"
	Vent	3 1/4"	-	3 1/4"
Min. visible width T-profile		1 7/8"	1 7/8"	1 7/8"
Overall system depth window	Frame	3 7/8"	3"	3"
	Vent	3 3/8"	2 15/16"	2 13/16"
Rebate height		9/16"	9/16"	9/16"
Glass thickness		up to 2 3/16"	up to 2 3/16"	up to 2 3/16"
Glazing method		dry glazing with EPDM or neutral silicones		
Thermal insulation		omega-shaped fibreglass reinforced polyamide strips (frame 1 9/16" – vent 1 1/4")		
High Insulation variant (HI)		available		

PERFORMANCE SPECIFICATIONS <sup>(1)</sup>		FIXED	OPERABLE		SWING DOOR			
<b>ENERGY</b>								
 Thermal Insulation <sup>(2)</sup> (Btu/hr-ft <sup>2</sup> ·°F) per NFRC 102	Fixed	Double	Triple	Double	Triple	Double	Triple	
		Uw	0.23	0.16				
	SHGC	0.19	0.21					
	Open in	Uw			0.25	0.19	0.30	0.25
		SHGC			0.20	0.17	0.09	0.10
	Open out	Uw			0.32	0.26	0.31	0.26
SHGC				0.16	0.15	0.09	0.10	
<b>COMFORT</b>								
 Acoustic performance <sup>(3)</sup> ASTM E90-09/1332	STC	45		42		38		
	OITC	38		35		34		
 Air tightness, max. test pressure <sup>(4)</sup> (cfm/ft <sup>2</sup> )	0.02		0.01		0.05			
 Water tightness <sup>(5)</sup> (psf)	12.11		12		11.28			
 AAMA Rating AAMA/WDMA/CSA 101/I.S.2/A440, NAFS	AW PG100		AW PG100		CW PG30 (Open In) CWPG40 (Open Out)			

This table shows classes and values of performances, which can be achieved for specific configurations and opening types.

- (1) All results based on gateway sizes; vary depending on glass/profile combinations | Above Uw & SHGC values do not necessarily work in combination.
- (2) Uw is the measure of heat transfer through the fenestration product with glass. The lower the Uw, the better the thermal insulation of the element.
- (3) The sound reduction index measures the capacity of the sound reduction performance of the frame and glass.
- (4) The air tightness test measures the volume of air that would pass through a closed window at a certain air pressure.
- (5) Water tightness testing applies a specified air pressure differential while simultaneously spraying water on to the ext. face of the assembly at the rate of 5 gal/hr/ft<sup>2</sup>.

REYNAERS ALUMINIUM • t. +1 480 272 9688

[www.reynaers.us](http://www.reynaers.us) • [info@reynaers.us](mailto:info@reynaers.us)

07/2021 – 00.SL38.00 – Publisher Responsible at Law: D. Willems  
 21430 N 15th Lane, Suite 100 | Phoenix, AZ 85027 | USA

# R

Reynaers  
Aluminium

TOGETHER FOR BETTER



Architect: G2  
Photo: Arroy