

MNS-300EM

Setting Manual



Index

1. Introduction	1
1-1. Introduction	2
MNS-300EM User's Manuals	2
Disclaimers.....	2
Trademarks	2
1-2. Safety Instructions	3
1-3. Product Information and Customer Services	6
Product Information.....	6
Customer Support Center	6
2. Product Overview	7
2-1. Features.....	8
2-2. Evaluation Board.....	11
2-3. Parts and Functions	12
2-4. MNS-300EM-EVK Interfaces.....	13
2-4-1. Serial Ports.....	13
D-Sub 9-Pin Connector	13
Logic Serial Port	13
RS-232C Cable Signals	14
2-4-2. Ethernet Port.....	14
2-4-3. Push Switch	14
2-4-4. Power.....	15
2-4-5. LED.....	15
2-5. Hardware Specifications	16
2-6. Optional Tools.....	21
2-6-1. AMC Manager®	21
2-6-2. Mesh Monitor	22
2-7. Radio Waves	23
2-7-1. Notes on Use.....	23

2-8. Notes on Security	25
3. Product Configuration	27
3-1. Configuration Methods.....	28
3-1-1. Configuration Methods.....	28
3-1-2. Connecting MNS-300EM with Firmware Version 2.00 or Lower.....	28
3-2. Configuration Using MNS-300EM's Web Page.....	29
3-2-1. How to Connect MNS-300EM-EVK and PC.....	29
3-2-2. MNS-300EM's Web Page	30
How to Access the MNS-300EM's Web Page	30
Menu Items on Web Page	32
3-2-3. Configuration on Web Page	34
3-3. Configuration Using AMC Manager®	36
3-3-1. How to Connect MNS-300EM-EVK and PC.....	36
3-3-2. Individual Configuration Using AMC Manager®	36
3-3-3. Bulk Configuration Using AMC Manager®	39
How to Create Configuration File	39
How to Execute Bulk Configuration	43
3-4. Configuration Using Command Console.....	50
3-4-1. How to Connect MNS-300EM-EVK and PC.....	51
3-4-2. How to Access Command Console	52
4. OEM Code Change	57
5. How to Connect Wireless Devices.....	59
5-1. Operating Mode	60
5-1-1. Mesh Point (MP) Mode.....	61
Mesh Networks	61
Mesh Profiles.....	62
MP Mode Setting.....	62
5-1-2. Station (STA) Mode	66
STA Mode Setting.....	66

5-2. Automatic Operating Mode Change.....	69
5-2-1. Auto Mode.....	69
5-2-2. Auto Mode Setting	71
6. Smart Wireless Setup	77
6-1. Features.....	78
6-2. Configuration Using Web Page	79
6-2-1. Push-Button Method	79
6-2-2. Pin-Code Method	81
6-3. Configuration Using Command Console.....	84
6-3-1. Push-Button Method	84
6-3-2. Pin-Code Method	85
7. Serial Device Communication.....	87
7-1. Ecable Mode.....	88
7-1-1. Communication Setting	88
7-2. Raw TCP Port	90
7-2-1. Communication Setting	90
8. GPIO Settings	93
8-1. GPIO Special Functions	94
8-2. How to Enable GPIO Special Functions on EVK.....	95
9. Security Function.....	97
9-1. Protocol Filter.....	98
9-2. IP Address Filter.....	100
10. Maintenance Functions.....	103
10-1. Factory Default Configuration.....	104
10-1-1. Factory Default Configuration Using Web Page.....	104
10-1-2. Factory Default Configuration Using Switch Signal.....	106
10-2. Firmware Update	107
10-2-1. How to Download Firmware.....	107

10-2-2. Firmware Update Using Web Page.....	107
10-2-3. Firmware Update Using AMC Manager®	110
10-2-4. Firmware Update Using tftp Command	114

A. Configuration Items on Web Page 115

Operating Mode Page	116
Station Mode Configuration Page	117
Smart Wireless Setup Page	124
Mesh Mode Configuration Page.....	125
General Configuration Page.....	129
Wired LAN Configuration Page	130
Wireless LAN Configuration Page.....	130
I/O Port Configuration S1 Page	131
I/O Port Configuration S2 Page	133
I/O Service Configuration A/B Page.....	134
Password Configuration Page.....	135
Access Control Configuration Page	135
Bluetooth Configuration Page.....	136

B. Wireless Configuration Using AMC Manager Mobile..... 137

B-1. AMC Manager Mobile.....	138
B-1-1. AMC Manager Mobile.....	138
B-1-2. How to Download AMC Manager Mobile	140
AMC Manager Mobile Operating Environment	140
How to Download AMC Manager Mobile	140
B-2. How to Enable Bluetooth Configuration Function	141
B-3. How to Copy Settings Using AMC Manager Mobile.....	143
B-4. Configuration Using AMC Manager Mobile	147

1. Introduction

Thank you for purchasing the Intelligent Module MNS-300EM.

1-1. Introduction

MNS-300EM User's Manuals

MNS-300EM has the following user's manuals:

MNS-300EM Setting Manual (this document)

This document explains the functions and configuration methods of MNS-300EM.

MNS-300EM Embedded Manual

This document describes the specifications and procedures for embedding MNS-300EM into the customer's product (hereinafter "target device").

MNS-300EM Command Manual

This document describes the console commands that can be used on MNS-300EM.

Please read **1-2. Safety Instructions** before you begin.

Disclaimers

- The unauthorized transfer or copying of the content of this manual, in whole or in part, without prior written consent is expressly prohibited by law.
- The content of this manual is subject to change without notice.
- Although every effort was made to prepare this manual with the utmost accuracy, Silex Technology will not be held liable for any damages as a result of errors, setting examples, or other content.

Trademarks



- AMC Manager® is a registered trademark of Silex Technology.
- Microsoft and Windows are either registered trademarks or trademarks of Microsoft Corporation in the United States and/or other countries.
- App Store is a trademark of Apple Inc., registered in the U.S. and other countries.
- Wi-Fi, Wi-Fi Protected Access (WPA), WPA2 are either registered trademarks or trademarks of Wi-Fi Alliance.
- Other brand or product names are registered trademarks or trademarks of their respective owners.

1-2. Safety Instructions







This page provides the safety instructions for safe use of MNS-300EM.

To ensure safe and proper use, please read the following information carefully before using MNS-300EM. The safety instructions include important information on safe handling of MNS-300EM and on general safety issues.



<Indication of the warning>

	Warning	<ul style="list-style-type: none"> "Warning" indicates the existence of a hazard that could result in death or serious injury if the safety instruction is not observed.
	Caution	<ul style="list-style-type: none"> "Caution" indicates the existence of a hazard that could result in serious injury or material damage if the safety instruction is not observed.

<Meaning of the symbols>



	<ul style="list-style-type: none"> This symbol indicates the warning and caution. (Example:  "Danger of the electric shock")
	<ul style="list-style-type: none"> This symbol indicates the prohibited actions. (Example:  "Disassembly is prohibited")
	<ul style="list-style-type: none"> This symbol indicates the actions users are required to observe. (Example:  "Remove the AC plug from an outlet")

 **Warning**

	<ul style="list-style-type: none"> • Do not disassemble or modify MNS-300EM. It may cause fire, electrical shock or malfunction. • Do not disassemble or modify the AC adapter that comes with the evaluation board of MNS-300EM. It may cause fire, electrical shock or malfunction.
	<ul style="list-style-type: none"> • Do not allow physical impact. When damaged, turn off the connected devices, unplug the AC plug of MNS-300EM from a power outlet and contact your point of purchase. Failure to take this action could cause fire or an electrical shock. • In the following cases, turn off the connected devices and unplug the AC plug of MNS-300EM from a power outlet and contact your point of purchase. Failure to take this action could cause fire or an electrical shock. <ul style="list-style-type: none"> - When MNS-300EM emits a strange smell, smoke or sound or becomes too hot to touch. - When foreign objects (metal, liquid, etc.) gets into MNS-300EM.
	<ul style="list-style-type: none"> • Keep the cords and cables away from children. It may cause an electrical shock or serious injury. • If a ground wire is supplied with your device to use with, connect it to the ground terminal in order to prevent an electrical shock. Do not connect the ground wire to gas pipe, water pipe, lighting rod or telephone ground wire. It may cause malfunction.



Caution

	<ul style="list-style-type: none"> • Do not place any objects on the cable or bend, twist, or pull it excessively. • Do not use or store MNS-300EM under the following conditions. It may cause malfunction. <ul style="list-style-type: none"> - Locations subject to vibration or shock - Shaky, uneven or tilted surfaces - Locations exposed to direct sunlight - Humid or dusty places - Wet places (kitchen, bathroom, etc.) - Near a heater or stove - Locations subject to extreme changes in temperature - Near strong electromagnetic sources (magnet, radio, wireless device, etc.)
	<ul style="list-style-type: none"> • When removing MNS-300EM, disconnect the AC plugs of both MNS-300EM and the other devices you are using with. • Verify all codes or cables are plugged correctly before using MNS-300EM. • When MNS-300EM will not be used for a long time, unplug the power cables of MNS-300EM and the other devices you are using with.
	<ul style="list-style-type: none"> • When unplugging the power plug of the evaluation board, do not pull the cord. The cord may be damaged and it may result in fire or electrical shock. Be sure to hold the plug when disconnecting it.

1-3. Product Information and Customer Services

Product Information

The services below are available from the Silex Technology website. For details, please visit the Silex Technology website.

Silex Technology website
 (URL) <https://www.silextechnology.com/>

- Latest firmware download
- Latest software download
- Latest manual download
- Support information (FAQ)

Customer Support Center

Customer Support is available for any problems that you may encounter. If you cannot find the relevant problem in this manual or on our website, or if the corrective procedure does not resolve the problem, please contact Silex Technology Customer Support.

Contact Information	
USA	support@silexamerica.com
Europe	support@silexeurope.com



Note

- Refer to the Silex Technology website (<https://www.silextechnology.com/>) for the latest FAQ and product information.

2. Product Overview

MNS-300EM is an intelligent module that can be embedded into a customer's product to make the product wireless. Since MNS-300EM can establish Mesh communication, customer products (e.g. serial devices, LAN devices) with MNS-300EM can easily join the Mesh network that is established using Silex Technology's products.

2-1. Features

MNS-300EM has the following features.

Wireless LAN standards IEEE802.11a/b/g/n/ac

Since MNS-300EM complies with IEEE802.11a/b/g/n/ac, the customer products can join a wireless LAN network after MNS-300EM is embedded. WEP, WPA, or WPA2 can be chosen as the wireless security setting. The supported encryption standards are 128-bit WEP, WPA (TKIP/AUTO) and WPA2 (AES). IEEE802.1X is supported and the authentication methods such as EAP-TLS, EAP-TTLS, LEAP, PEAP and EAP-FAST can be used.

Customer products can join Mesh network

MNS-300EM supports Mesh communication. The customer products with MNS-300EM can establish a Mesh network with Silex Technology's Mesh network products (hereafter Mesh devices). Up to 32 Mesh devices can be used to establish a single Mesh network. MNS-300EM can connect with 10 Mesh devices at maximum.



- Up to 10 devices can be connected to MNS-300EM at a time. When 11 devices are all connecting each other, the 12th device cannot join the wireless communication.

Two operating modes

[Mesh Point (MP) mode]

- When MNS-300EM is operating in MP mode, it relays radio waves from the other Mesh device in the Mesh network. Using MNS-300EM as a relay device, wired devices or serial devices can connect to the Mesh network as well. MNS-300EM of MP mode can connect to Silex Technology's products operating in MP or MAP (Mesh Access Point) mode.

[Station (STA) mode]

- When MNS-300EM is operating in STA mode, it can connect to an Access Point as a wireless client device and join the wireless network.

Automatic operating mode switch

MNS-300EM automatically changes the operating mode depending on the wireless environment conditions. While MNS-300EM is establishing a connection, it chooses the operating mode (STA or MP) according to the Access Point and Mesh devices with the highest radio intensity.

Up to 5 Mesh network profiles can be saved

MNS-300EM can save up to five profiles of connecting Mesh networks. When the auto-switching function of the operating mode is enabled, MNS-300EM compares the radio strength and chooses the Mesh network to connect.

Serial communication

As MNS-300EM supports the following communication modes, it can be flexibly used for your environment and system.

[Ecable Mode]

- MNS-300EM enables serial devices with no network interface to join the network and establish serial communication. For more details, see **7-1. Ecable Mode**.

[Raw TCP Mode]

- MNS-300EM is capable of receiving and sending data of the serial port over TCP/IP communication and establishes communication with an application program that uses Socket API. For details, see **7-2. Raw TCP Port**.

Easy wireless configuration

When your Access Point supports WPS (Wi-Fi Protected Setup), the configuration method using the push button/PIN code can be used for wireless configuration of MNS-300EM.

Unified management software "AMC Manager®"

MNS-300EM can work with the unified management software, "AMC Manager®".

The following functions are supported:

- Remote device control and monitoring
- Bulk configuration and version upgrade
- Visualization of Mesh networks by using Mesh Monitor (sold separately)



- For details of AMC Manager® and Mesh Monitor, see the Silex Technology's website.

Note

Compatible interfaces

MNS-300EM and other Silex Technology's intelligent IEEE802.11bgn/abgn modules have the same shape and dimensions, and their pins are compatible. By replacing the Silex Technology's product to MNS-300EM, the target device can be connected to a Mesh network.

2-2. Evaluation Board

MNS-300EM-EVK (evaluation board) is available to use as a development tool for MNS-300EM. This evaluation board is equipped with RJ-45 Ethernet connector, serial connectors, and connectors for major I/O signals, and which can be used to develop the necessary software and hardware.

MNS-300EM-EVK contains the following items. Make sure that none of them are missing and damaged. If you find a damaged or missing accessory, please contact Silex Technology.

Package contents

- MNS-300EM-EVK
- Wireless LAN antenna (dual-band)
- AC adapter
- RS-232C cable (crossover) (1.5 m)
- Network cable (2.0 m)
- USB cable (1.0 m)

In this document, MNS-300EM-EVK is used in order to explain the configuration/connection methods.

2-3. Parts and Functions

This page describes the parts and functions of MNS-300EM-EVK.

For MNS-300EM, see **MNS-300EM Embedded Manual**.

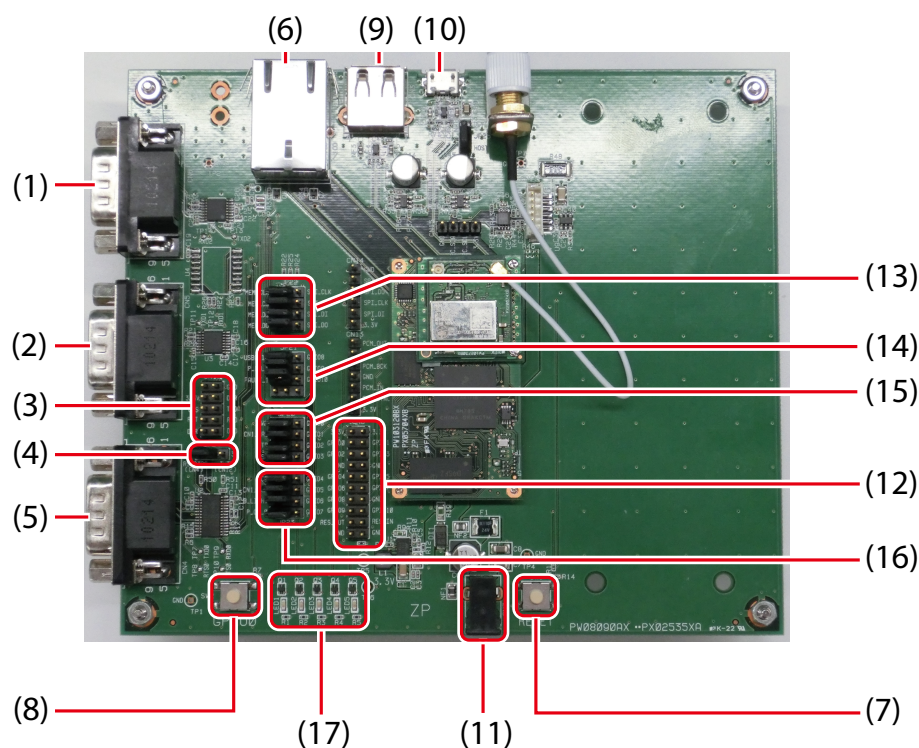

No.	Connector No.	Name	Description
(1)	CN6	Serial port 3 (D-sub 9-pin connector)	Connects an RS-232C cable.
(2)	CN5	Serial port 2 (D-sub 9-pin connector)	Connects an RS-232C cable.
(3)	CN12	Logic serial port 1 (10-pin connector)	Used for serial communication without RS-232C cable.
(4)	JP24	4-bit jumper to select RS-232C	Enables/disables serial communication for CN12.
(5)	CN4	Serial port 1 (D-sub 9-pin connector)	Connects an RS-232C cable.
(6)	CN1	Ethernet port	Connects a network cable.
(7)	SW1	Push switch 1	Performs a hardware reset of MNS-300EM.
(8)	SW2	Push switch 2	Initializes the MNS-300EM settings.
(9)	CN3	USB Host port	Connects a USB cable (Type-A connector).
(10)	CN2	USB Host port	Connects a USB cable (Micro-AB connector).
(11)	CN7	Power connector	Connects the AC adapter.
(12)	CN8	20-pin connector	Used for GPIO signal connection of MNS-300EM.
(13)	JP22	4-bit jumper to select SPI	Used for SPI signal connection of MNS-300EM.
(14)	JP21	4-bit jumper to select GPIO	Used for assignment of GPIO special functions.
(15)	JP20		
(16)	JP23		
(17)	LED1 to 5	LED1 to LED5	Used for checking GPIO signals.

2-4. MNS-300EM-EVK Interfaces

2-4-1. Serial Ports

D-Sub 9-Pin Connector

MNS-300EM-EVK has D-Sub 9-pin male connectors (CN4, CN5, CN6) for standard RS-232C serial signal output. The following table shows the connector details.

Connector No.	Name	Description
CN4	Serial port 1	<ul style="list-style-type: none"> Performs hardware flow control with RTS/CTS modem control signals. Supports DCD/DTR/DSR by configuring the jumper-switch on JP20 and JP23 of MNS-300EM-EVK.
CN5	Serial port 2	<ul style="list-style-type: none"> Connects to the configuration application for a console configuration task. Linux functions cannot be used from the serial port 2.
CN6	Serial port 3	<ul style="list-style-type: none"> Linux console that can access the Linux system on MNS-300EM. Does not support the modem signals. The communication settings are as follows: <ul style="list-style-type: none"> Speed: 115200 bps Parity: None Flow control: None Number of data bits: 8 bits

Logic Serial Port

Serial port 1 can also be used from the 10-pin connector (CN12) on MNS-300EM-EVK. Using the 10-pin connector allows a direct access of 3.3V logic signals without using D-Sub 9-pin and RS-232C. To use the 10-pin connector, a jumper needs to be set on 3.3V connector of JP24 to disable RS-232C transceiver.

The following table shows the 10-pin connector's pin allocation.

PIN	SIGNAL	Input/Output	PIN	SIGNAL	Input/Output
1	DCD	Input	2	DSR	Input
3	RXD	Input	4	RTS	Output
5	TXD	Output	6	CTS	Input
7	DTR	Output	8	3.3V	-
9	GND	-	10	(Not connected)	-

All the signal lines are 0 to 3.3V logic signals.

RS-232C Cable Signals

The following table shows a wire connection of the serial cable (D-Sub 9-pin, female to female) that comes with MNS-300EM-EVK. The pin layout is compatible with industry-standard PC. By directly connecting the serial port 3 of MNS-300EM-EVK to the PC using the serial cable, MNS-300EM settings can be configured. Also, the target device (with PC-compatible 9-pin connector) can be connected to the serial port 1 or 2 of MNS-300EM-EVK using the serial cable.

PIN	Description
1	DCD (Data Carrier Detect) Input
2	RxD (Receive Data) Input
3	TxD (Transmit Data) Output
4	DTR (Data Terminal Ready) Output
5	Ground
6	DSR (Data Set Ready) Input
7	RTS (Request To Send) Output
8	CTS (Clear To Send) Input
9	NC

2-4-2. Ethernet Port

The Ethernet port (CN1) of MNS-300EM-EVK is used for configuration and test.

By connecting MNS-300EM-EVK and PC using a network cable, the MNS-300EM setting can be configured.

2-4-3. Push Switch

MNS-300EM-EVK is equipped with two push switches: SW1 and SW2.

MNS-300EM monitors signals on the push switches, and performs the following operations when the switches are pressed.

[SW1]

SW1 is associated with the reset signal.

If SW1 is pressed and then released while MNS-300EM is operating, MNS-300EM is restarted.

[SW2]

SW2 is associated with the switch signal (GPIO1_0) and 4.7KΩ pull-up resistor to +3.3VDC. If SW2 is pressed, it will be connected to the ground, and the switch signal will be low.

If MNS-300EM operates in Auto mode and SW2 is pressed for 4 seconds or less, re-scan of wireless environments will begin. For more details, see **5-2-1. Auto Mode**.

If SW2 is pressed for 5 seconds or longer, MNS-300EM will be reset to the factory default settings. For more details, see **10-1. Factory Default Configuration**.

2-4-4. Power

The power is supplied to MNS-300EM and MNS-300EM-EVK from the power jack (CN7) at 5V +/-5%. Use the AC adapter that comes with MNS-300EM-EVK.



- Be sure to always use the AC adapter that comes with MNS-300EM.

2-4-5. LED

The status LED (orange) at the Ethernet port (CN1) shows the MNS-300EM's operating status. The following table shows the lighting pattern.

LED Name	Pattern	State
Status LED	On	Connected to a network (wired/wireless).
	Off	No network is connected.
	Blinking	Updating the firmware.

2-5. Hardware Specifications

SoC	i.MX6ULL series MCIMX6Y1CVM05AA
Memory	ROM: 32 Mbytes RAM: 128 Mbytes Low Voltage DDR3
Wired network interface	10BASE-T / 100BASE-TX
Wireless network interface	IEEE 802.11a/b/g/n/ac Bluetooth 4.1
Antenna connector	U.FL x 1
Operating voltage	5.0V +/- 5%
Push switch	x 2
Supported interface	USB 2.0 OTG x 2 UART x 3 I2C x 1 (*1) SPI x 1 (*1) SDIO / MMC x 1 (*1) Flex CAN x 1 (*1)
Operating condition	Temperature: -40 to +85 degrees Celsius (*2)
	Humidity: 15% to 95% RH (No condensation)
Storage condition	Temperature: -40 to +85 degrees Celsius
	Humidity: 15% to 95% RH (No condensation)

(*1) The functions are directly connected to SoC signals, however, it is required to develop a software program to use them.

(*2) The internal temperature of SoC must not exceed +105 degrees Celsius.

Notice to US Customers



Contains FCC ID: N6C-SDMAC

FCC Rules Part 15

FCC CAUTION

Changes or modifications not expressly approved by the party responsible for compliance could void the user's authority to operate the equipment.

FCC Rules Part 15 §15.19(a)(3)

This device complies with Part 15 of the FCC Rules. Operation is subject to the following two conditions:

- (1) This device may not cause harmful interference, and
- (2) this device must accept any interference received, including interference that may cause undesired operation.

FCC Rules Part 15 Subpart C §15.247 and Subpart E

This equipment complies with FCC radiation exposure limits set forth for an uncontrolled environment and meets the FCC radio frequency (RF) Exposure Guidelines. This equipment should be installed and operated keeping the radiator at least 20cm or more away from person's body.

FCC Rules Part 15 Subpart E §15.407(c)

Data transmission is always initiated by software, which is passed down through the MAC, through the digital and analog baseband, and finally to the RF chip. Several special packets are initiated by the MAC. These are the only ways the digital baseband portion will turn on the RF transmitter, which it then turns off at the end of the packet. Therefore, the transmitter will be on only while one of the aforementioned packets is being transmitted. In other words, this device automatically discontinues transmission in case of either absence of information to transmit or operational failure.

FCC Rules Part 15 Subpart E §15.407(g)

Frequency Tolerance: +/-20 ppm

FCC Rules Part 15 Subpart C §15.247(g) / Subpart E

This device and its antenna(s) must not be co-located or operation in conjunction with any other antenna or transmitter.

Notice to Canadian Customers

Contains IC: 4908A-SDMAC

RSS-Gen Issue 5 §8.4

This device contains licence-exempt transmitter(s)/receiver(s) that comply with Innovation, Science and Economic Development Canada's licence-exempt RSS(s). Operation is subject to the following two conditions:

1. This device may not cause interference.
2. This device must accept any interference, including interference that may cause undesired operation of the device.

L'émetteur/récepteur exempt de licence contenu dans le présent appareil est conforme aux CNR d'Innovation, Sciences et Développement économique Canada applicables aux appareils radio exempts de licence. L'exploitation est autorisée aux deux conditions suivantes :

1. L'appareil ne doit pas produire de brouillage;
2. L'appareil doit accepter tout brouillage radioélectrique subi, même si le brouillage est susceptible d'en compromettre le fonctionnement.

RSS-Gen Issue 5 §6.8

This radio transmitter 4908A-SDMAC has been approved by Innovation, Science and Economic Development Canada to operate with the antenna types listed below, with the maximum permissible gain indicated.

Antenna types not included in this list that have a gain greater than the maximum gain indicated for any type listed are strictly prohibited for use with this device.

Antenna type	Gain	Impedance
Pole antenna(ANTDP-027A0)	2.4GHz: 1.5dBi 5GHz: 2.1 dBi	50Ω
Pole antenna(ANTDC-081A0/B0)	2.4GHz: 2.0dBi 5GHz: 2.0 dBi	50Ω
Flex antenna(1461530100)	2.4GHz: 3.25dBi 5GHz: 5.0 dBi	50Ω
PCB antenna(H2B1PC1A1C)	2.4GHz: 2.9dBi 5GHz: 4.4 dBi	50Ω
Chip antenna(H2U84W1H1S)	2.4GHz: 1.4dBi 5GHz: 2.3 dBi	50Ω

Le présent émetteur radio 4908A-SDMAC a été approuvé par Innovation, Sciences et Développement économique Canada pour fonctionner avec les types d'antenne énumérés ci-dessous et ayant un gain admissible maximal. Les types d'antenne non inclus dans cette liste, et dont le gain est supérieur au gain maximal indiqué pour tout type figurant sur la liste, sont strictement interdits pour l'exploitation de l'émetteur.

Type d'antenne	Gain	l'impédance
Antenne pôle(ANTDP-027A0)	2,4GHz : 1,5dBi 5GHz : 2,1dBi	50Ω
Antenne pôle(ANTDC-081A0/B0)	2,4GHz : 2,0dBi 5GHz : 2,0dBi	50Ω
Antenne d'équilibre(1461530100)	2,4GHz : 3,25dBi 5GHz : 5,0dBi	50Ω
Antenne PCB(H2B1PC1A1C)	2,4GHz : 2,9dBi 5GHz : 4,4dBi	50Ω
Antenne à puce(H2U84W1H1S)	2,4GHz : 1,4dBi 5GHz : 2,3dBi	50Ω

RSS-247 Issue 2 §6.2.2.2

for indoor use only (5150-5350 MHz)

Pour usage intérieur seulement (5150-5350 MHz)

RSS-247 Issue 2 §6.4

Data transmission is always initiated by software, which is the passed down through the MAC, through the digital and analog baseband, and finally to the RF chip. Several special packets are initiated by the MAC. These are the only ways the digital baseband portion will turn on the RF transmitter, which it then turns off at the end of the packet. Therefore, the transmitter will be on only while one of the aforementioned packets is being transmitted. In other words, this device automatically discontinues transmission in case of either absence of information to transmit or operational failure.

La transmission des données est toujours initiée par le logiciel, puis les données sont transmises par l'intermédiaire du MAC, par la bande de base numérique et analogique et, enfin, à la puce RF. Plusieurs paquets spéciaux sont initiés par le MAC. Ce sont les seuls moyens pour qu'une partie de la bande de base numérique active l'émetteur RF, puis désactive celui-ci à la fin du paquet. En conséquence, l'émetteur reste uniquement activé lors de la transmission d'un des paquets susmentionnés. En d'autres termes, ce dispositif interrompt automatiquement toute transmission en cas d'absence d'information à transmettre ou de défaillance.

RSS-102 Issue 5 §2.6

This equipment complies with ISED radiation exposure limits set forth for an uncontrolled environment and meets RSS-102 of the ISED radio frequency (RF) Exposure rules. This equipment should be installed and operated keeping the radiator at least 20cm or more away from person's body.

Cet équipement est conforme aux limites d'exposition aux rayonnements énoncées pour un environnement non contrôlé et respecte les règles d'exposition aux fréquences radioélectriques (RF) CNR-102 de l'ISDE. Cet équipement doit être installé et utilisé en gardant une distance de 20 cm ou plus entre le radiateur et le corps humain.

2-6. Optional Tools

MNS-300EM supports the following optional tools.

- AMC Manager®
- Mesh Monitor

As the optional tools can be used for bulk configuration/device management and can visually show the Mesh network, a time of maintenance could be reduced.

2-6-1. AMC Manager®

AMC Manager® is an unified management software that allows the users to remotely monitor the status of Silex products and change the configuration individually and collectively using the IP network.

AMC Manager® provides a list of operating status for MNS-300EN units.

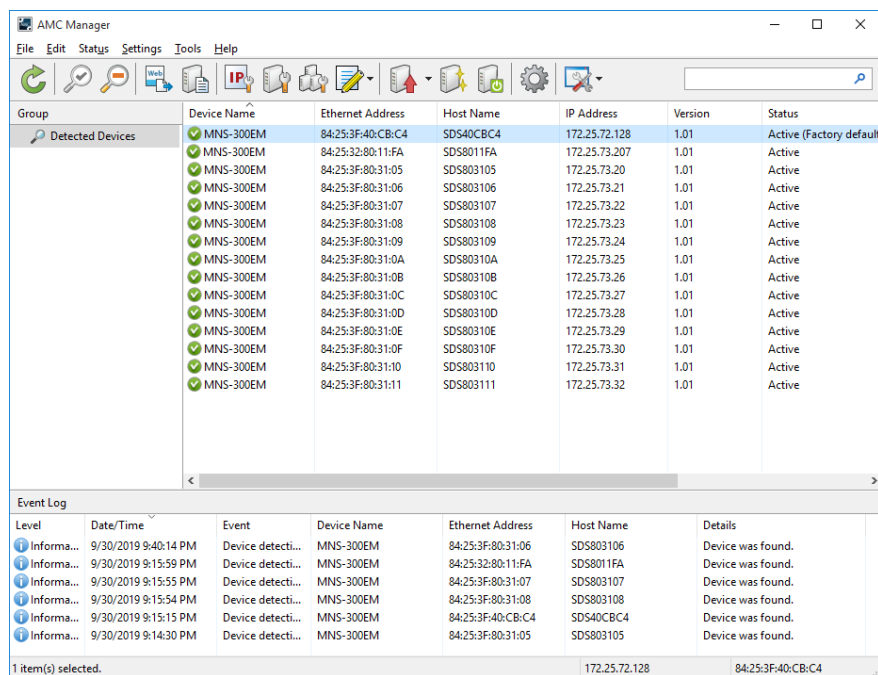

The screenshot displays the AMC Manager application window. The main area shows a table of detected devices with columns for Group, Device Name, Ethernet Address, Host Name, IP Address, Version, and Status. Below this is an Event Log table with columns for Level, Date/Time, Event, Device Name, Ethernet Address, Host Name, and Details. The status bar at the bottom indicates 1 item(s) selected.

Group	Device Name	Ethernet Address	Host Name	IP Address	Version	Status
Detected Devices	MNS-300EM	84:25:3F:40:CB:C4	SDS40CBC4	172.25.72.128	1.01	Active (Factory default)
	MNS-300EM	84:25:32:80:11:FA	SDS8011FA	172.25.73.207	1.01	Active
	MNS-300EM	84:25:3F:80:31:05	SDS803105	172.25.73.20	1.01	Active
	MNS-300EM	84:25:3F:80:31:06	SDS803106	172.25.73.21	1.01	Active
	MNS-300EM	84:25:3F:80:31:07	SDS803107	172.25.73.22	1.01	Active
	MNS-300EM	84:25:3F:80:31:08	SDS803108	172.25.73.23	1.01	Active
	MNS-300EM	84:25:3F:80:31:09	SDS803109	172.25.73.24	1.01	Active
	MNS-300EM	84:25:3F:80:31:0A	SDS80310A	172.25.73.25	1.01	Active
	MNS-300EM	84:25:3F:80:31:0B	SDS80310B	172.25.73.26	1.01	Active
	MNS-300EM	84:25:3F:80:31:0C	SDS80310C	172.25.73.27	1.01	Active
	MNS-300EM	84:25:3F:80:31:0D	SDS80310D	172.25.73.28	1.01	Active
	MNS-300EM	84:25:3F:80:31:0E	SDS80310E	172.25.73.29	1.01	Active
	MNS-300EM	84:25:3F:80:31:0F	SDS80310F	172.25.73.30	1.01	Active
	MNS-300EM	84:25:3F:80:31:10	SDS803110	172.25.73.31	1.01	Active
	MNS-300EM	84:25:3F:80:31:11	SDS803111	172.25.73.32	1.01	Active

Level	Date/Time	Event	Device Name	Ethernet Address	Host Name	Details
Informa...	9/30/2019 9:40:14 PM	Device detecti...	MNS-300EM	84:25:3F:80:31:06	SDS803106	Device was found.
Informa...	9/30/2019 9:15:59 PM	Device detecti...	MNS-300EM	84:25:32:80:11:FA	SDS8011FA	Device was found.
Informa...	9/30/2019 9:15:55 PM	Device detecti...	MNS-300EM	84:25:3F:80:31:07	SDS803107	Device was found.
Informa...	9/30/2019 9:15:54 PM	Device detecti...	MNS-300EM	84:25:3F:80:31:08	SDS803108	Device was found.
Informa...	9/30/2019 9:15:15 PM	Device detecti...	MNS-300EM	84:25:3F:40:CB:C4	SDS40CBC4	Device was found.
Informa...	9/30/2019 9:14:30 PM	Device detecti...	MNS-300EM	84:25:3F:80:31:05	SDS803105	Device was found.

1 item(s) selected. 172.25.72.128 84:25:3F:40:CB:C4

AMC Manager® has two versions; AMC Manager® Free (free license) and AMC Manager® (non-free license). The non-free version can control more devices simultaneously, and the plugin functions such as Mesh Monitor, etc. can be used with.

Functions	AMC Manager® Free (Free license)	AMC Manager® (Non-free license)
Number of devices displayed in the list	Max 10 units	Max 10,000 units
Simultaneous operation	Max 10 units	Max 10,000 units
Plugins (e.g. Mesh Monitor)	Not accepted	Accepted



- Please purchase the license key to use AMC Manager® (non-free license).
- To purchase the license key, please contact Silex Technology. The contact information can be found at **1-3. Product Information and Customer Services.**

2-6-2. Mesh Monitor

Mesh Monitor is a non-free AMC Manager® plugin utility. It can visualize the Mesh network route and the operating status of Mesh devices (including MNS-300EM) to ease the Mesh network management.

- Actual device location

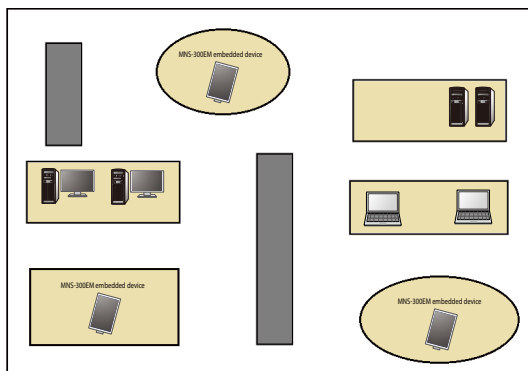

- Display on Mesh Monitor

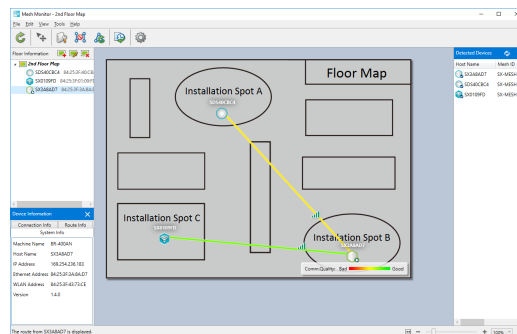

- For MNS-300EM, it is impossible to set the route filter on Mesh Monitor.
- Mesh Monitor is not included in AMC Manager®.
- Since Mesh Monitor is a non-free plugin, the license key is required for the installation in addition to the license of AMC Manager®.
- To purchase the license key, please contact Silex Technology. The contact information can be found at **1-3. Product Information and Customer Services.**

2-7. Radio Waves

2-7-1. Notes on Use

Do not use MNS-300EM near the following devices or places.

- Industrial, scientific and medical devices (e.g. microwave, pacemaker, etc.)
- Licensed radio station in a factory
- Small power radio station (A non-licensed radio station)

These devices may use the same band. If you use MNS-300EM near these devices, the radio waves emitted from MNS-300EM may interfere with them.

Do not use MNS-300EM near a cellular phone, TV or Radio.

A cellular phone, TV and radio use a different radio band than our products. Generally, if they are used near MNS-300EM, it will not cause any problems. However, when they approximate MNS-300EM, sound or image noise may occur.

If there is reinforced concrete/metal between wireless devices, they may not connect.

MNS-300EM can connect through wood or glass, but may have troubles connecting through reinforced concrete/metal.

MNS-300EM complies with the certification of conformance to technical standards.

Please pay attention to the following points:

- Please do not disassemble or remodel the product. Such action is prohibited by law.
- Please do not remove the certificate label. Using the product without a label is prohibited.

Wireless devices using 2.4GHz band

The same frequency band of MNS-300EM is used for a microwave, industry, science, medical equipment and licensed in room or low power (non-licensed) radio stations.

- Before you use MNS-300EM, check that it does not interfere with other devices.
- If interference occurs, stop using MNS-300EM or change the wireless band. Please consider to create a wall between these devices to avoid interference. Contact us for possible solution.

- * The meaning of the symbols in the bottom of the unit:

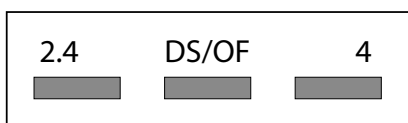

2.4	: Wireless devices using 2.4GHz frequency band
DS/OF	: DS-SS or OFDM is used as modulation.
4	: The range of interference is equal to or lower than 40m.
	: All bands can be used to avoid interference.

Notes on using 5GHz band

- Use of 5.2GHz band (W52) and 5.3GHz band (W53) outdoors is prohibited by the radio law. When MNS-300EM is used outdoors, use W56 channels only and do not use W52/W53 channels.

2-8. Notes on Security

Because a wireless LAN uses electromagnetic signals instead of a network cable to establish communication with network devices, it has the advantage of allowing devices to connect to the network easily. However, a disadvantage of this is that within a certain range, the electromagnetic signals can pass through barriers such as walls, and if security countermeasures are not implemented in some way, problems such as the following may occur.

- Communication is intercepted by a third party
- Unauthorized access to the network
- Leakage of personal information (ID and Card information)
- Spoofing and the falsification of intercepted data
- System crashes and data corruption

Nowadays, wireless LAN cards or access points are equipped with security measures that address such security problems, so that you can enable security-related settings for wireless LAN products in order to reduce the likelihood of problems occurring.

We recommend that you make yourself fully acquainted with the possible implications of what might happen if you use a wireless product without enabling security features, and that you configure security-related settings and use wireless products at your own responsibility.

(Blank Page)

3. Product Configuration

This chapter describes how to configure the MNS-300EM settings.

3-1. Configuration Methods

3-1-1. Configuration Methods

There are the following configuration methods.

Use a Web browser

Access the MNS-300EM's Web page to change the settings.

Use AMC Manager®

Use AMC Manager® to change the settings. By creating a configuration file, multiple MNS-300EM units can be configured at once.

Use the command console

Execute commands from the command console to change the settings.

Some settings cannot be changed by the Web page or AMC Manager® and can be changed by the console command only.

3-1-2. Connecting MNS-300EM with Firmware Version 2.00 or Lower

Execute one of the followings when MNS-300EM is connected to an older version of MNS-300EM (Ver 2.00 or lower) in the Mesh network.

- Update the older version of MNS-300EM to the latest version. Make sure that all MNS-300EM units have the same setting for **Route Switching Mode** and **Transmission Control Function**, then.
- When different versions of MNS-300EM units are used together, select **Responsive Type** for **Route Switching Mode** on all MNS-300EM units with firmware version 2.00 or later.

3-2. Configuration Using MNS-300EM's Web Page

3-2-1. How to Connect MNS-300EM-EVK and PC

1. Connect MNS-300EM-EVK and PC using the network cable (CAT 5).

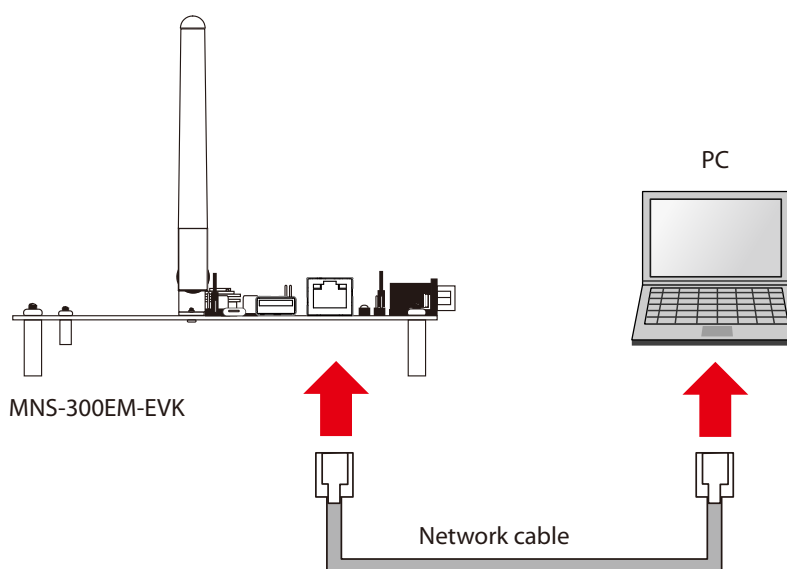

2. Connect the AC adapter to MNS-300EM-EVK to turn on it (1) (2).

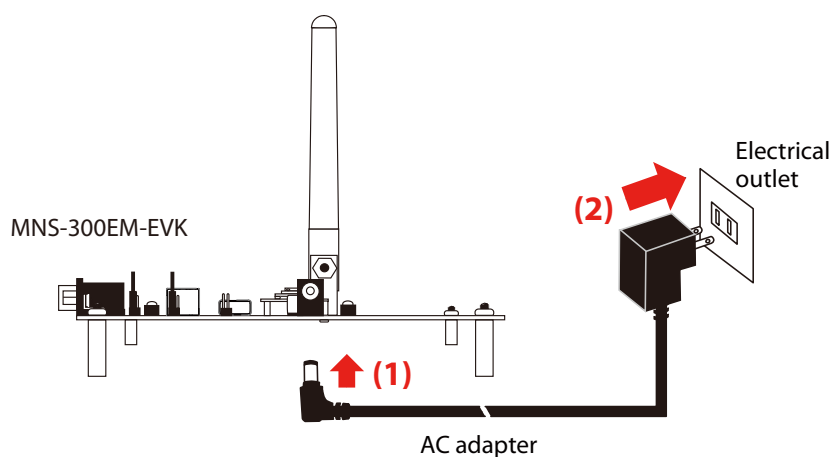

3-2-2. MNS-300EM's Web Page

How to Access the MNS-300EM's Web Page

1. Access the MNS-300EM's Web page using the IP address.

When you are sure of what IP address is set:

Start a Web browser on PC and enter the IP address of MNS-300EM in the address bar. Go to the step 2 when the Web page appears.

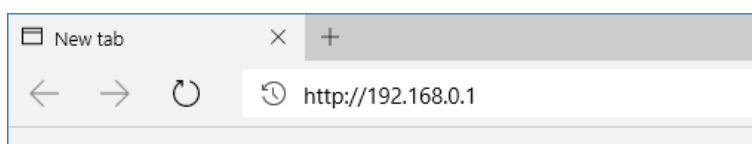

When you are not sure of what IP address is set:

Use AMC Manager® to access the Web page.

AMC Manager® can be downloaded from the Silex Technology's website.

(<https://www.silextechnology.com/>)

When AMC Manager® starts, connectable MNS-300EM units are shown in the device list. Choose MNS-300EM to configure, and click the icon **Configure using Web browser**. When the Web page appears, go to the step 2.

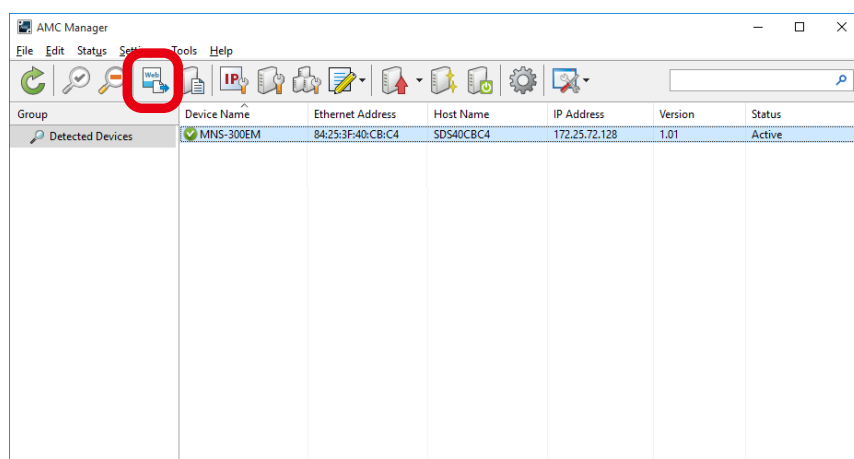

- When the login password configuration page appears, enter the password to configure for MNS-300EM(1) and click **Submit**(2).

■ Welcome to MNS-300EM

Please set a login password for this unit.

Password :

Confirm Password : 8 letters[max]

Select Language : English

Submit

- Log in the Web page to configure the settings.

silex technology

Select Language
English

▼ Status
- System

▼ Login
- Login

- silex Global Site

■ System Status

System Status Refresh HELP

▶ TCP/IP Information

Name	Status
IP Address	192.168.47.200
Subnet Mask	255.255.255.0
Default Gateway	0.0.0.0
DHCP Server	0.0.0.0

▶ Wireless LAN Information

Name	Status
Mesh Group Name	SX-MESH-NET D6-BE-C4-EA-61-50
Current Channel	11

▶ Wired LAN Information

Name	Status
Link Status	Ethernet link Up

Menu Items on Web Page

The configuration can be changed after logging in the Web page.
There are following menu items in the Web page.

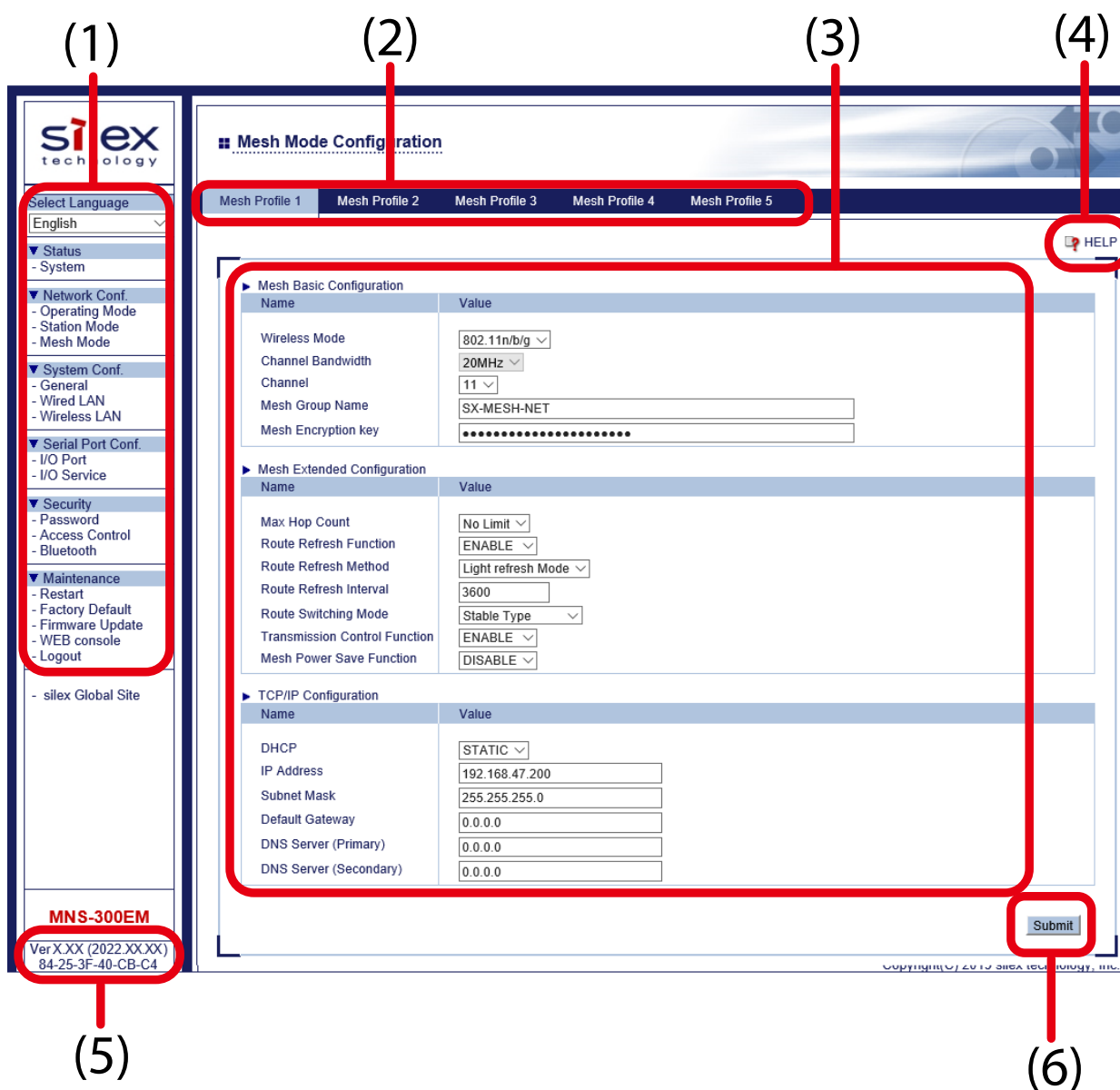

(1) Page menu

If clicked, the configuration page is changed.

(2) Tab

The tab is displayed when there are multiple pages for the configuration. If the tab is clicked, the configuration page is changed.

(3) Configuration page

Each setting can be configured.

(4) Help link

The Help page is displayed. The Help page provides the detailed explanation of each setting.

(5) Firmware version/MAC address

The firmware version and MAC address of MNS-300EM are displayed.

(6) Submit button

If clicked, the changes you made to the configuration page will be saved.

(You may need to scroll-down the screen to find this button.)



- Be sure to change the password when MNS-300EM is connected to a public network.
- The wireless bands of IEEE 802.11b/g and IEEE 802.11n/b/g are often in use by someone as a large number of wireless devices are using that bands. In such a case, you may not be able to procure enough communication bands for your use.

3-2-3. Configuration on Web Page

1. Access the Web page and click **Login** from the menu.

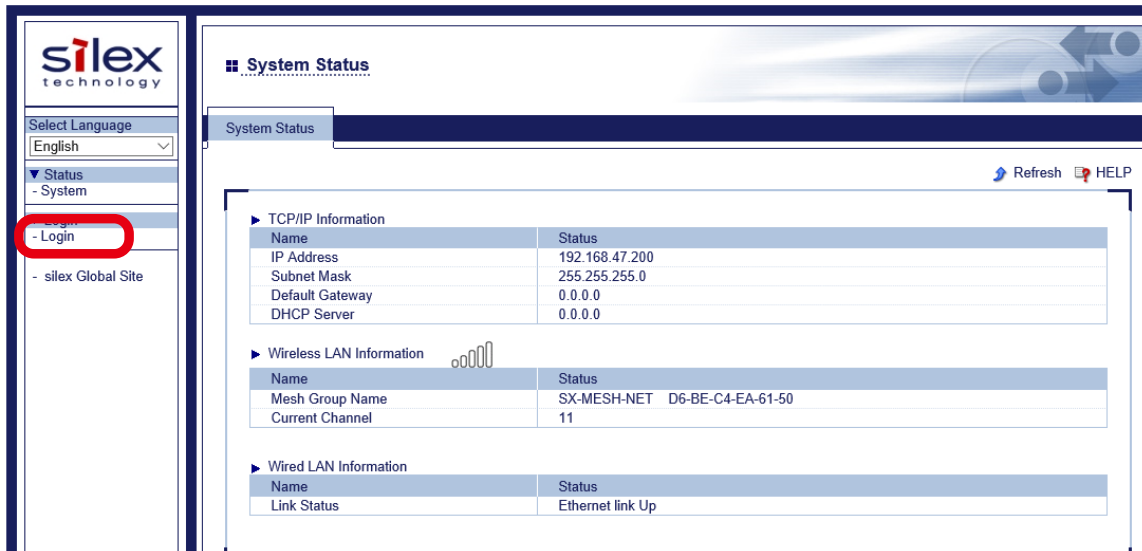

2. Enter the password(1) and click **Login** (2).



3. The system status page appears again.

Choose the configuration page and enter the setting. When the input is completed, click **Submit** at the right bottom of the page.



System Status

System Status

Refresh HELP

TCP/IP Information

Name	Status
IP Address	192.168.47.200
Subnet Mask	255.255.255.0
Default Gateway	0.0.0.0
DHCP Server	0.0.0.0

Wireless LAN Information

Name	Status
Mesh Group Name	SX-MESH-NET D6-BE-C4-EA-61-50
Current Channel	11

Wired LAN Information

Name	Status
Link Status	Ethernet link Up



TIP

- Be sure to click **Submit** to save the current setting before you move to other configuration page. If the other configuration page is displayed before **Submit** is clicked, the entered setting will be cleared.
- To configure the other settings, choose the page from the menu or page tab.

4. To take effect of the changes, restart MNS-300EM.

Click **Restart** from the menu and click **Yes** in the displayed page.

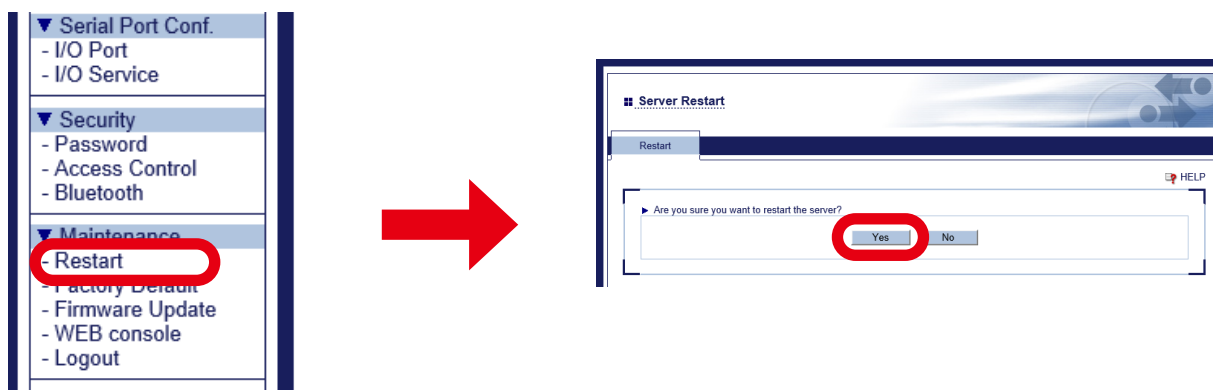

Serial Port Conf.

- I/O Port
- I/O Service

Security

- Password
- Access Control
- Bluetooth

Maintenance

- **Restart**
- Factory Default
- Firmware Update
- WEB console
- Logout

Server Restart

Restart

Are you sure you want to restart the server?

Yes No

3-3. Configuration Using AMC Manager®

This chapter describes how to configure the MNS-300EM settings using AMC Manager®. There are two ways of configuration methods; individual configuration and bulk configuration.

3-3-1. How to Connect MNS-300EM-EVK and PC

Connect one end of network cable (CAT 5) to the Ethernet connector of MNS-300EM-EVK and the other end to PC. For details, see **3-2-1. How to Connect MNS-300EM-EVK and PC.**

3-3-2. Individual Configuration Using AMC Manager®

The following pages show how to configure a single MNS-300EM using AMC Manager®.

1. Start AMC Manager®. When AMC Manager® is started, MNS-300EM is displayed in a device list. Select MNS-300EM to configure, and click the icon **Configure the device**.

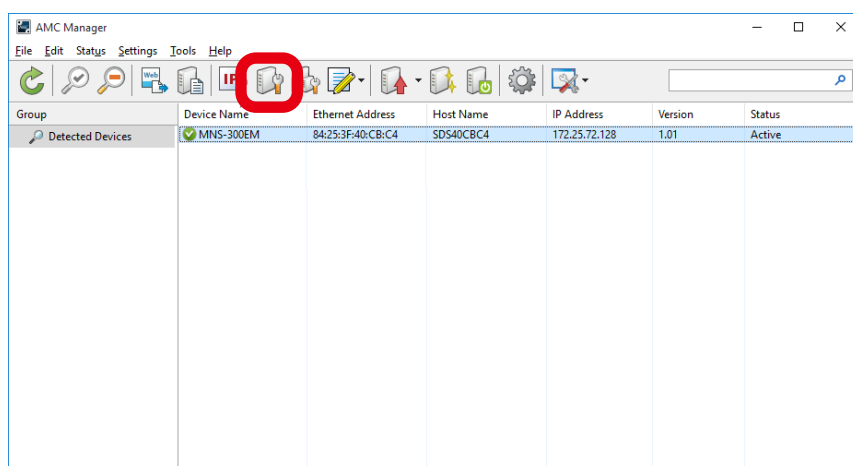

- The password input window appears.
Enter the password(1) and click **OK** (2).

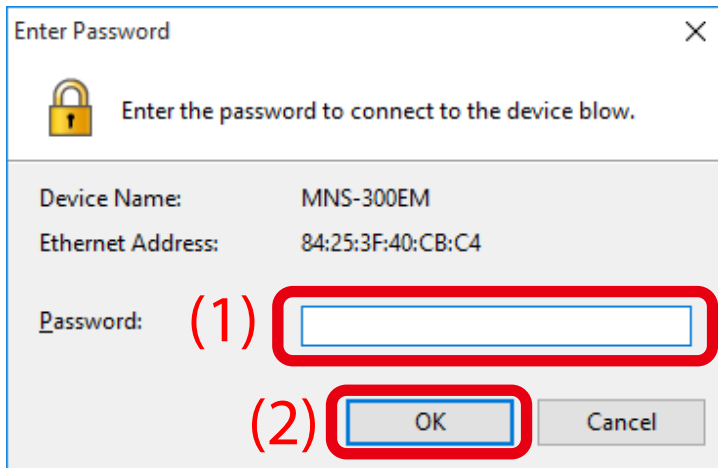

Enter Password

Enter the password to connect to the device blow.

Device Name: MNS-300EM
Ethernet Address: 84:25:3F:40:CB:C4

Password: (1)

(2)

**Note**

- When the login password is not set to the device, the window below is displayed. Enter the login password to configure for the device and click **Register**. When the password registration is completed, the device list is displayed. Start from **1** again.

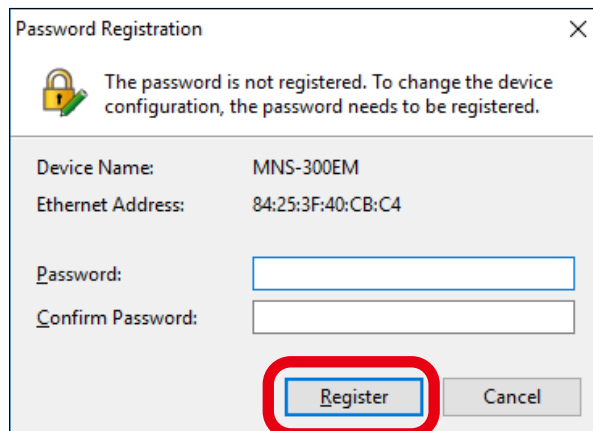

Password Registration

The password is not registered. To change the device configuration, the password needs to be registered.

Device Name: MNS-300EM
Ethernet Address: 84:25:3F:40:CB:C4

Password:
Confirm Password:

- The device configuration window appears. Tick check boxes of the items to update, and change the values (1). When necessary values are changed, tick the check box of **Restart the device after this configuration** (2), and click **Execute** (3).

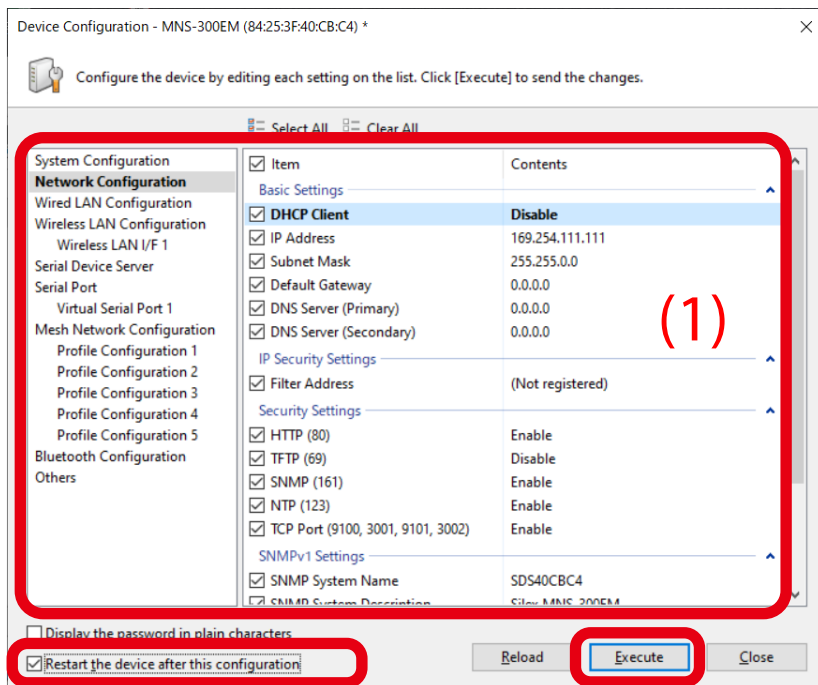

(2)

(3)

- The configuration result is displayed. MNS-300EM will automatically restart and operate with the new settings.

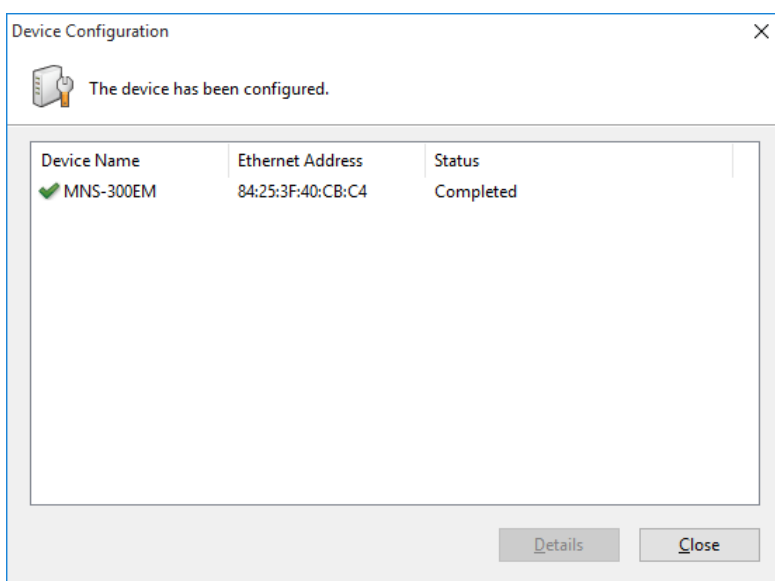

3-3-3. Bulk Configuration Using AMC Manager®

The following pages show how to configure multiple MNS-300EM units at once using AMC Manager®. For bulk configuration, a configuration file needs to be created in advance.

How to Create Configuration File

The following pages show how to create the configuration file for bulk configuration using AMC Manager®.



- When the login password is not set to a device, please include that setting to the configuration file. If the login password is not set, the bulk configuration does not perform correctly.

1. Start AMC Manager® on PC.

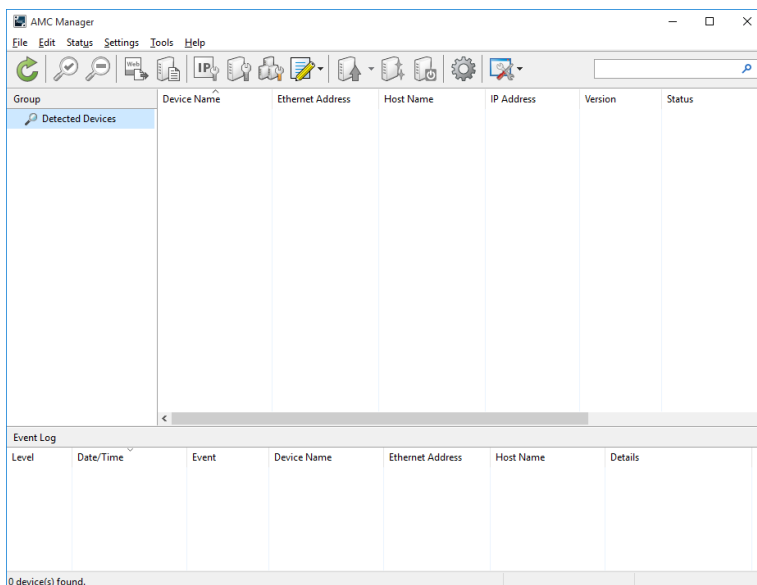

- Click the icon **Create the configuration file** on the toolbar and choose **Create from Template**.

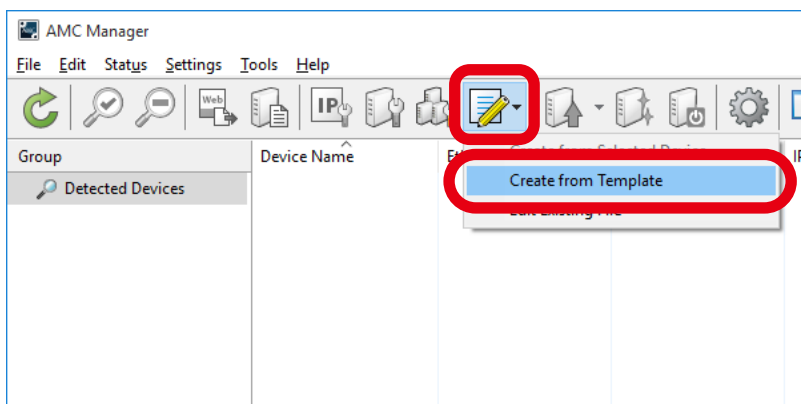

Note

- When the configuration file has already been made, it can be edited. For such a case, click the icon **Create the configuration file** and select **Edit Existing File**.

- Choose a template file for MNS-300EM (1) and click **OK** (2).

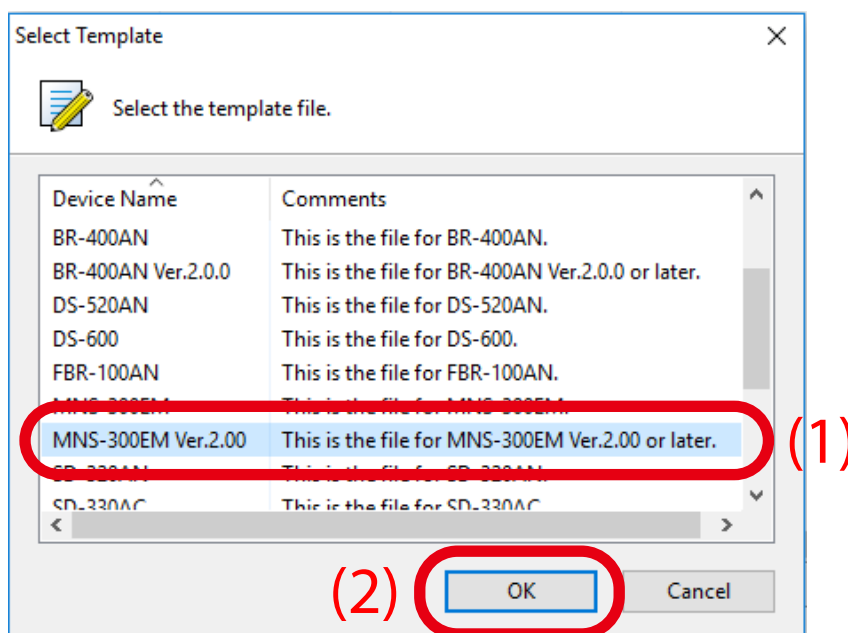

TIP

- The template to select will vary depending on the firmware version of MNS-300EM.
When the version is 2.00 or higher: Select **MNS-300EM Ver.2.00**.
When the version is 2.00 or lower: Select **MNS-300EM**.

4. Selecting the target configuration category from the menu (1) will display the corresponding settings on the left (2).

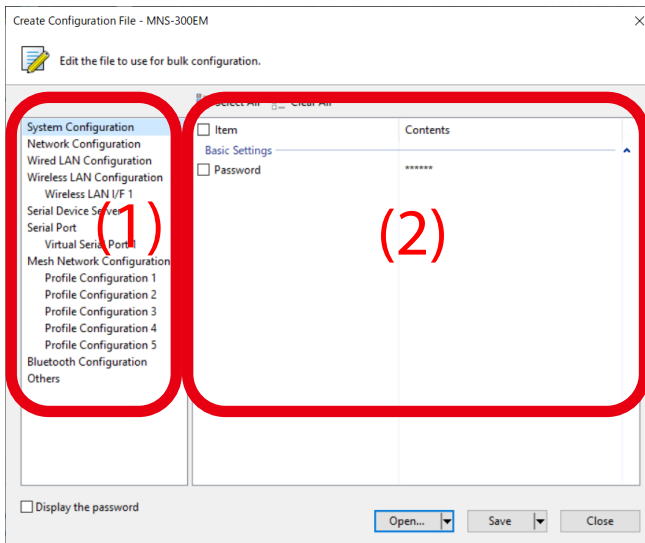

5. Tick check boxes of the items to configure, and edit the values (1), and click **Save** (2).

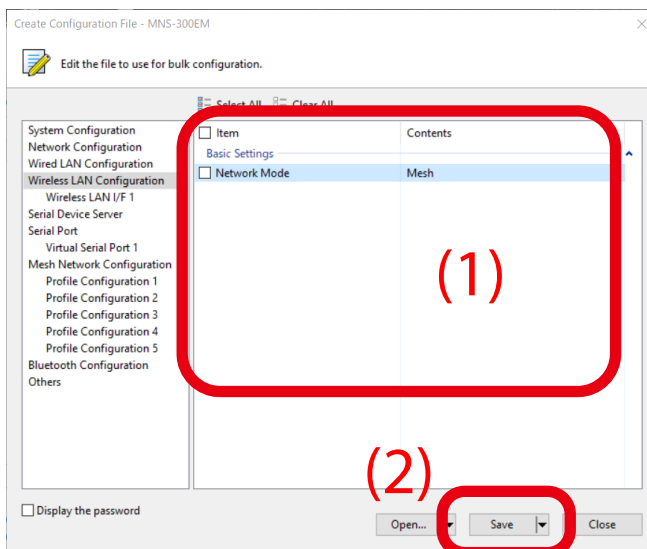

- If an IP address is specified in the configuration file, such address will be configured to all devices when the same configuration file is used for them. Clear the check box of IP address to avoid it.
- Some settings may not be applied to MNS-300EM depending on combinations of setting items.



Note

- The setting whose check box is checked will be configured to MNS-300EM. For the setting you do not want to change, clear the check box.
- It is recommended to set/change the password to protect the setting information.
- Please be careful not to forget the **Password, Mesh Group ID, Mesh Encryption Key, SSID, Security Key (WEP Key or Pre-Shared key)** to configure.
- It is possible to configure an IP address to several devices at once using AMC Manager®.

6. Enter the file name in **File name** (1) and click **Save** (2).

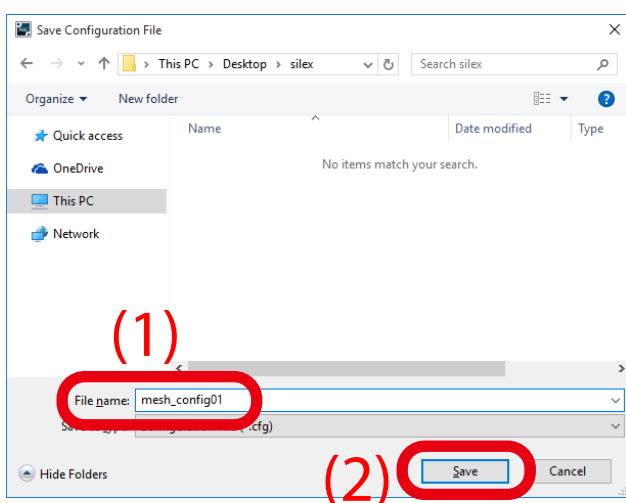

After the configuration is saved, the screen of the step 4 is displayed again.
To create a configuration file for each Mesh network group, repeat the step 4-6.

When the configuration file is created, the preparation for bulk configuration is completed. Click **Close** then.

How to Execute Bulk Configuration

Multiple MNS-300EM units can be configured at once using the configuration file that you have created at **How to Create Configuration File**.

1. For the bulk configuration of IP address, the IP address of the PC needs to be changed beforehand. Change the IP address of the PC to the one that can be communicated with MNS-300EM units after the bulk configuration.

Setting example)

IP addresses for MNS-300EM	IP address for PC
192.168.0.10 - 192.168.0.30	192.168.0.100
172.25.10.10 - 172.25.10.25	172.25.10.100



- The bulk configuration of IP address can be used for initial configuration.

- Prepare MNS-300EM and MNS-300EM-EVK, and turn on them to establish Mesh network. Connect PC with one of MNS-300EM-EVK.

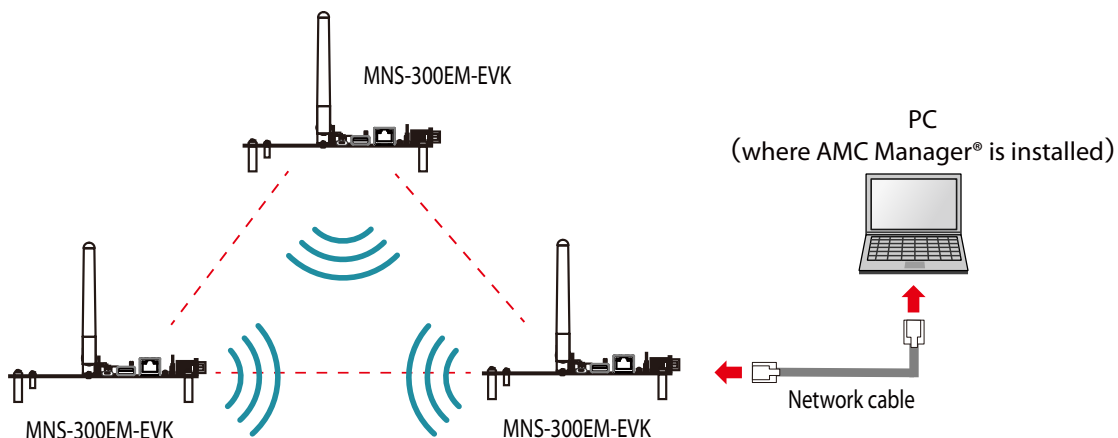

- The MNS-300EM units to configure should temporarily be placed in a close location to configure the Mesh network.

- Start AMC Manager® on PC. MNS-300EM units are displayed on the device list when they are active on the Mesh network.

The screenshot shows the AMC Manager software interface. A table titled 'Detected Devices' is highlighted with a red box and labeled 'Device List'. The table contains the following data:

Device Name	Ethernet Address	Host Name	IP Address	Version	Status
MNS-300EM	84:25:3F:40:CB:C4	SDS40CBC4	172.25.72.128	1.01	Active
MNS-300EM	84:25:3F:80:11:FA	SDS8011FA	172.25.73.207	1.01	Active
MNS-300EM	84:25:3F:81:31:05	SDS813105	172.25.73.20	1.01	Active
MNS-300EM	84:25:3F:81:31:06	SDS813106	172.25.73.21	1.01	Active



- If the MNS-300EM units are not displayed on the device list, click the icon **Refresh**.
- It may take approximately 1 min to show MNS-300EM units on the device list depending on your environment.

4. Select the MNS-300EM units to configure at once (1) and click the icon **Configure multiple devices in bulk** (2).

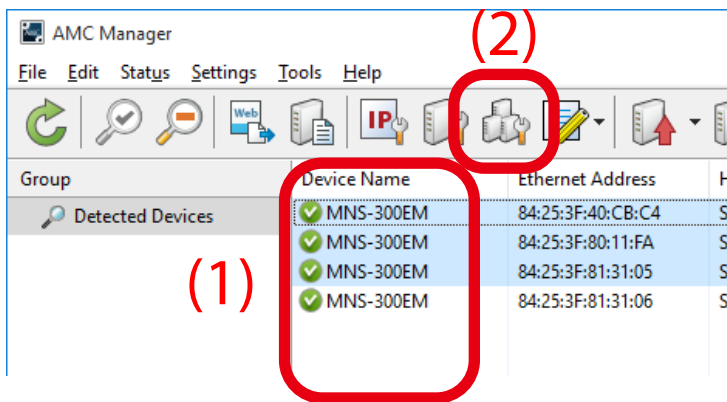

5. Specify the configuration file. Select MNS-300EM units to configure (1) and click **Select Config. File** (2).

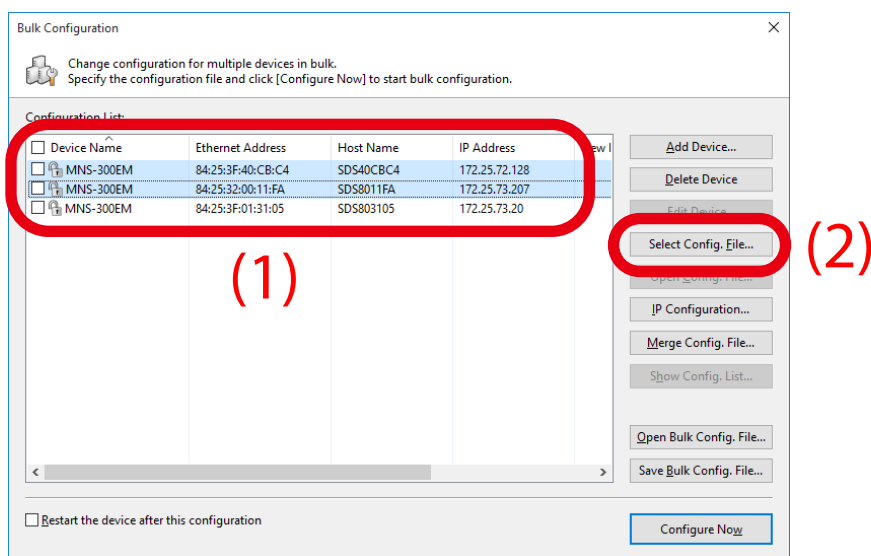

6. Select the configuration file that you have created beforehand.

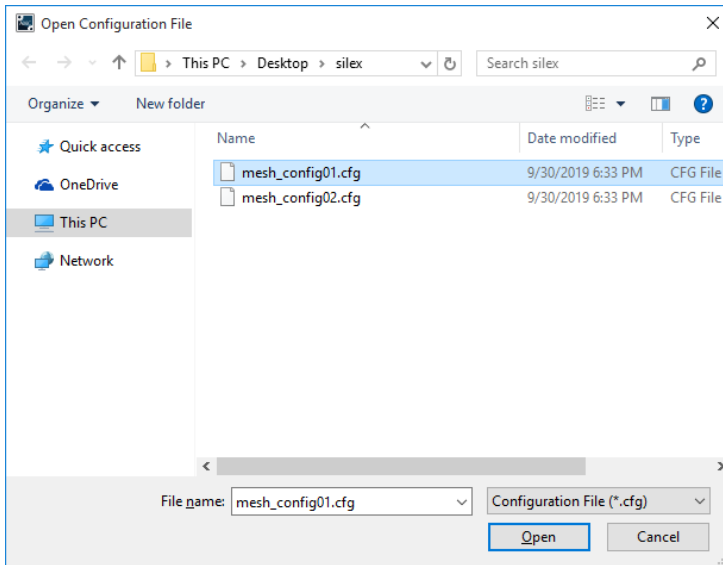

7. The selected configuration file is displayed under **Configuration File Name**. Repeat the step 5-6 to specify the configuration file for all MNS-300EM units.

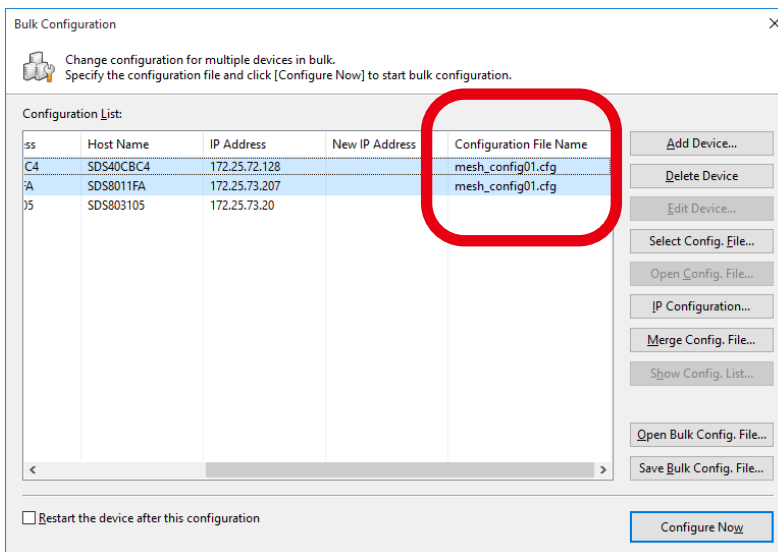

8. When the configuration file is specified for all MNS-300EM units (1), click **IP Configuration** (2).

When the IP address is automatically configured by DHCP server, skip this and go on to the step 11.

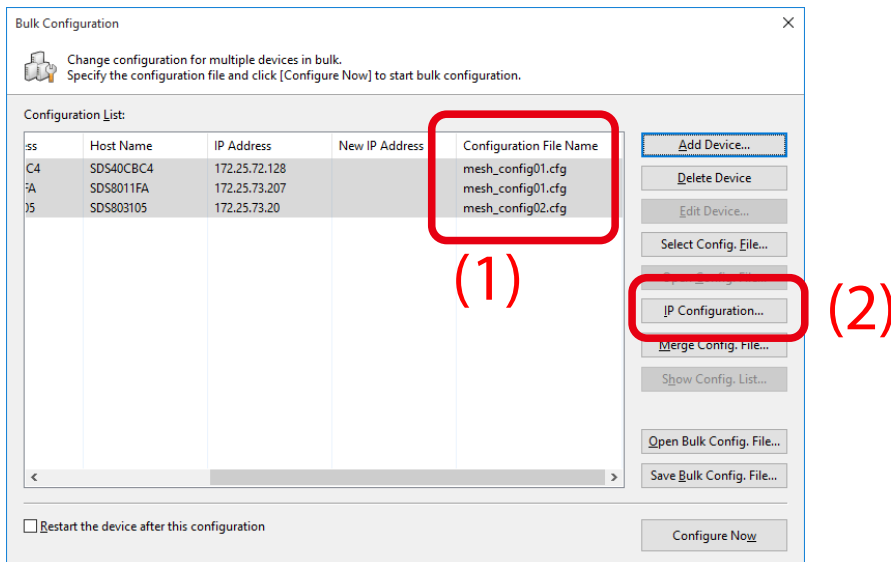

9. Specify the IP address range to configure for MNS-300EM units (1).
When the setting is finished, click **OK** (2).

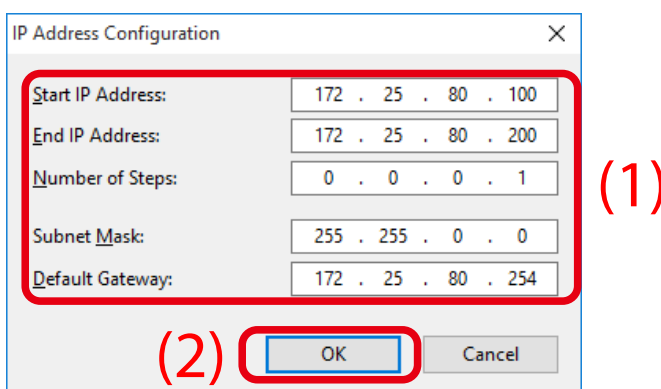

Note

- In this example, when IP addresses are applied to three units of MNS-300EM, the first MNS-300EM's IP address will be the start IP address: 172.25.72.100. As the IP address increases by "0.0.0.1" (see "Number of Steps"), 172.25.72.101 will be allocated for the second device and 172.25.72.102 for the third device.

10. IP addresses are allocated for MNS-300EM units and are shown under **New IP Address**.

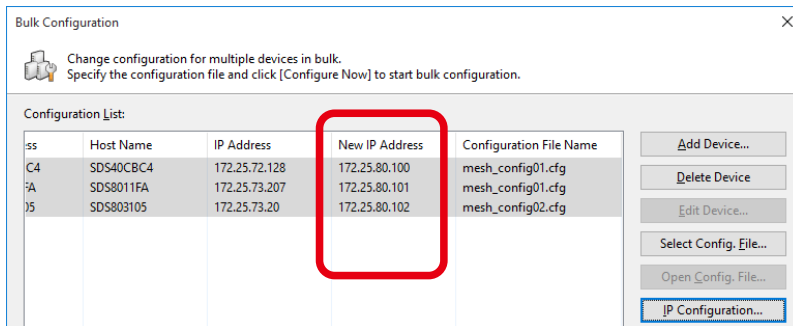

- All IP addresses of MNS-300EM (under Mesh profiles settings and Station mode settings) will be changed to the **New IP Addresses**.

11. Tick check boxes of MNS-300EM units to configure (1) and click **Configure Now** (2).

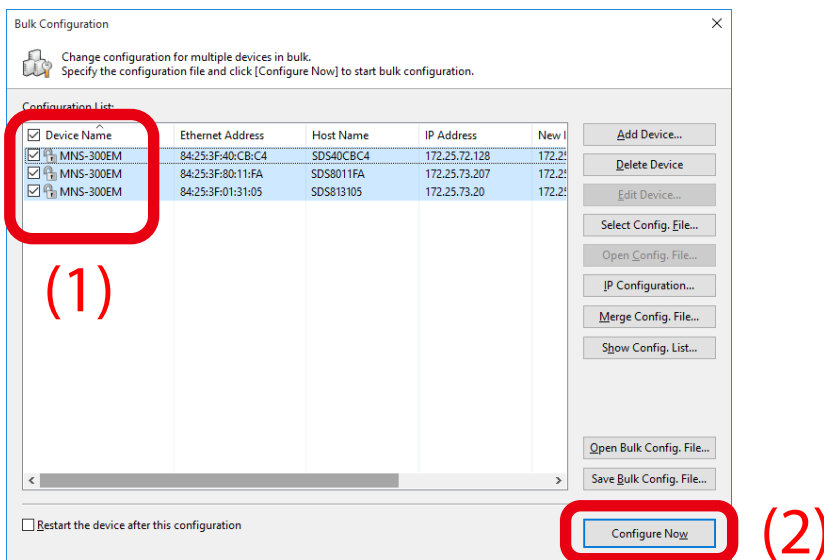

- Please do not check the check box at **Restart the device after this configuration**. The configuration may fail as it makes all MNS-300EM units restart regardless of the Mesh network status when the configuration is completed.



Note

- For changes to take effect, MNS-300EM needs to be restarted.
- If the check box at the left of **Device Name** is checked, all check boxes are checked.

12. The progress bar is displayed during the configuration and the result is displayed when the configuration is completed. Click **Close** when the configuration is completed.

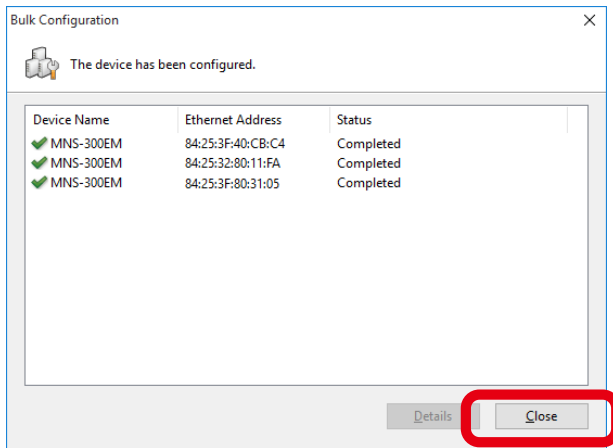

- If the result status does not say "Completed", modify the setting of the configuration file and try again.

TIP

The bulk configuration has been completed.

MNS-300EM will operate with new settings after it is restarted.

3-4. Configuration Using Command Console

The command console is one of configuration methods using a command line.

The command console allows a fine control for a wide variety of settings compared to what the Web page or AMC Manager® does. The command line method is for experts who are familiar with functions and specifications of MNS-300EM.

This chapter describes how to configure the setting using the command console.



- Refer to **MNS-300EM Command Manual** for the supported console commands.

Note

3-4-1. How to Connect MNS-300EM-EVK and PC

Connect MNS-300EM-EVK and PC using RS-232C cable.

Connect the cable to Serial Port 2 or 3 of MNS-300EM-EVK. The PC's serial port setting has to be changed to the following value.

- Speed: 115200 bps
- Parity: None
- Flow control: None
- Number of data bits: 8 bits

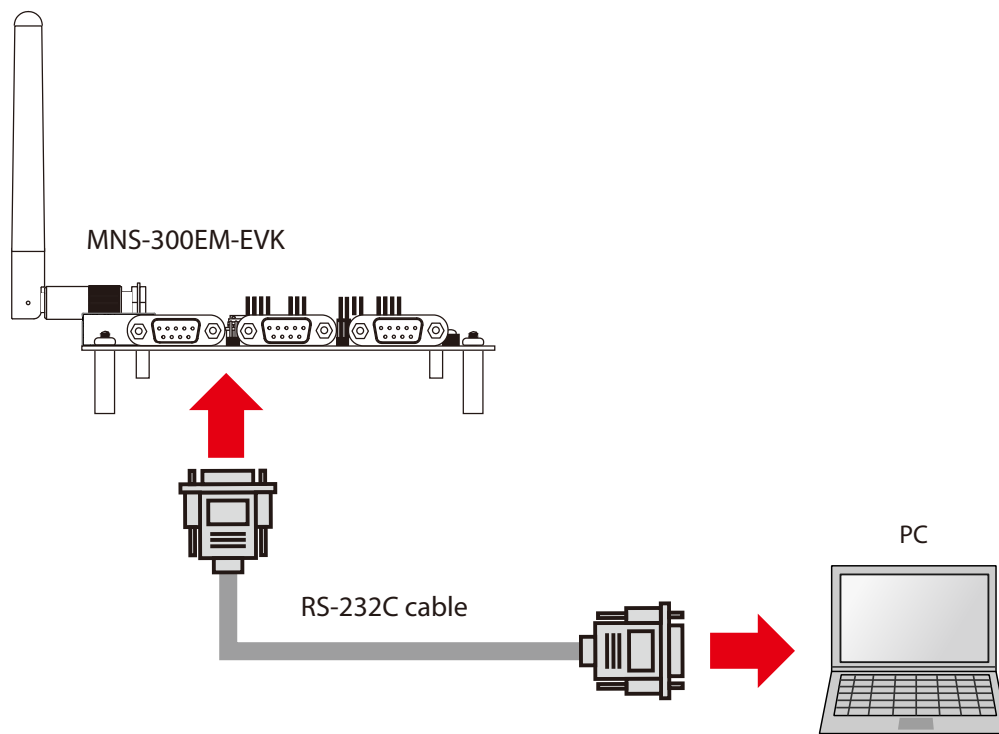

Note

- The PC operates as a console port for command line configuration and check.
- Serial Port 3 operates as a Linux console that can access the Linux system of MNS-300EM-EVK. Serial Port 2 connects to the configuration application and connects to the console configuration task. It is impossible to access the Linux system from Serial Port 2.

3-4-2. How to Access Command Console

1. Turn on MNS-300EM-EVK that has been connected to PC using RS-232C cable (1), (2).

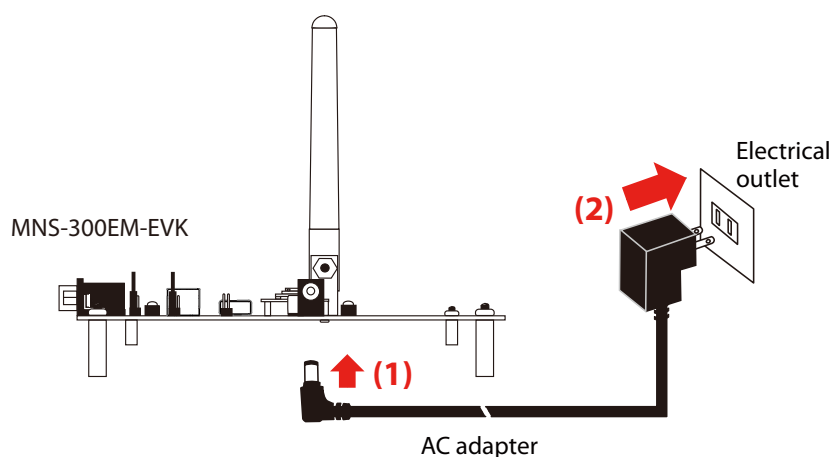
**Note**

- When MNS-300EM-EVK is not used, connect MNS-300EM's 50-pin connector (31/33, 36/38, or GND pins) to a terminal console. For the pin allocation, see **2-2-2. Pin Allocation for Interface Connector** of **MNS-300EM Embedded Manual**.

2. When RS-232C cable is connected to Serial Port 3, the terminal console shows the product and system names. When the **login:** prompt is shown, enter the user name and password.

- User name: **admin**
- Password: Enter the password for MNS-300EM.

By default, no password is configured to MNS-300EM.

When RS-232C cable is connected to Serial Port 2, skip this procedure and go on to the step 3.

- 3.** When **Local>** is shown on the terminal, enter the MNS-300EM's commands.
(When Serial Port 2 is connected, **Local>** will be displayed if any key is pressed.)

First, configure the operating mode of MNS-300EM by the following command.

SET NW MODE <mode> Enter STATION, MESH or AUTO for <mode>.

Commands for settings vary depending on the specified operating mode.

- 4.** By factory defaults, automatic IP address configuration using DHCP is enabled.
To apply a static IP address, execute the following commands.

Configuration for MP mode:

SET MESH [profile_num] IPMethod STATIC

SET MESH [profile_num] IPADDRESS aa.bb.cc.dd

SET MESH [profile_num] IPSUBNET aa.bb.cc.dd

SET MESH [profile_num] IPROUTER aa.bb.cc.dd

Configuration for STA mode:

SET IP METHOD STATIC

SET IP ADDRESS aa.bb.cc.dd

SET IP SUBNET aa.bb.cc.dd

SET IP ROUTER aa.bb.cc.dd

Specify the Mesh profile number for [profile_num] of MP mode. [aa.bb.cc.dd] needs to be specified in an IP address format.

For AUTO mode, both MP and STA mode settings are needed.

5. Configure the general settings according to the operating mode.

Configuration for MP mode:

SET MESH PROFSElect [profile_num]

Enter the Mesh profile number for [profile_num].

**SET MESH [profile_num] MOde
<mode>**

Choose the wireless mode for the MP mode operation.
Enter the Mesh profile number for [profile_num]. Specify 11G,
11NG, 11A, 11NA, or 11AC for <mode>.

**SET MESH [profile_num] CHannel
<number>**

Enter the Mesh profile number for [profile_num]. Enter the
channel for <number>.

**SET MESH [profile_num] GRoup
<name>**

Enter the Mesh profile number for [profile_num]. Enter the
group name of Mesh network for <name>.

SET MESH [profile_num] KEY <key>

Enter the Mesh profile number for [profile_num]. Enter the
Mesh encryption key for <key>.

Configuration for STA mode:

SET NW SSID <name>

Enter the network SSID for <name>.

For STA mode, the authentication and encryption settings of the step 6 is necessary.

Configuration for AUTO mode:

**SET MESH [profile_num] PROFile
[ENable | DISable]**

Enable or disable the Mesh profile used for Auto mode. Enter
the Mesh profile number for [profile_num].

ENable: Enable the Mesh profile.

DISable: Disable the Mesh profile.

For AUTO mode, both MP and STA mode settings are needed.

6. The wireless LAN encryption and authentication methods need to be specified when MNS-300EM is used in STA mode. (For MP mode, skip this procedure and go on to the step 7.)

SET NW ENC <mode> Set the encryption mode. Specify DIS, 128, WPA, WPA2, or WPA2-WPA for <mode>.

SET NW AUTHTYPE <type> Set the authentication mode. Specify OPEN, PSK, TTLS, PEAP, LEAP, TLS, or EAP-FAST for <type>.

Execute the following command for the specified encryption and authentication methods.

For WPA2-PSK or WPA-PSK:

SET NW WPAPSK <psk> Set the pre-shared key in <psk> for WPA2 or WPA.

For WEP128:

SET NW KEY# n Set 1-4 for 'n' for WEP key index.
(default value: 1)

SET NW KEYVAL <key> Enter 26 hexadecimal digits for <key> as the WEP key.



- See **MNS-300EM Command Manual** for details on necessary commands for IEEE 802.1X EAP authentication.

7. Execute the following commands to configure the serial port settings. (For Serial Port 2 settings, replace S1 to S2 in the following commands.)

SET PORT S1 SPEED <baudrate>	Enter a numerical value (300-3000000) for <baudrate>.
SET PORT S1 PARITY <parity>	Enter ODD, EVEN, or None for <parity>.
SET PORT S1 CH <databits>	Specify 7 or 8 for <databits>.
SET PORT S1 FLOW <flowcontrol>	Enter NONE, XON/XOFF, or CTS for <flowcontrol>.

8. When the configuration is completed, execute the following commands to terminate the command console.

INIT

EXIT

MNS-300EM saves the setting and restarts. After the restart is completed, MNS-300EM can be used in the specified environment.



- To save the setting configured by the console commands, execute the **EXIT** or **SAVE** commands when you finish the console command.

4. OEM Code Change

This chapter describes how to change the OEM code of MNS-300EM.

The registered company name and information can be changed by using the command console. The three-character OEM code for the server and service names can be changed from the default one ("SDS") to any three characters.

For example, if it is changed to "XYZ", the server name will be changed from "SDS000345" (default name) to "XYZ000345". Execute the following commands from the command console to change the values.

SET OEM <code>	Enter three-character OEM code for <code>.
SET DEFAULT	Reset MNS-300EM to the factory default settings.
SET SERVER DESC <description>	Enter the server name (32 characters or less) for <description>. (Spaces are accepted. No need to use quotation marks.)
INIT	Restart MNS-300EM after the console mode is terminated.
EXIT	Terminates the console mode.



- Be sure to execute the **SET OEM** command first as the setting configured by this command will take effect on a parameter after MNS-300EM is reset to the factory default setting.



Note

- See **3-4. Configuration Using Command Console** for how to access the command console.

5. How to Connect Wireless Devices

This chapter describes how to connect MNS-300EM to wireless devices.

The information of Access Point / Mesh network to connect need to be registered to MNS-300EM beforehand to establish the communication.

5-1. Operating Mode

MNS-300EM can operate in the following three operating modes. The destination devices and necessary settings vary for each operating mode.

The operating mode can be changed in the **Operating Mode** page.

Operating mode	Web setting	Destination	Required information
MP mode	Mesh	Mesh network (MP, MAP)	Settings of Mesh network to connect
STA mode	Station	Access point, MAP	Settings of an Access Point to connect
Auto mode	Auto	Mesh networks (MP, MAP), Access point	Settings of Mesh networks (one or more networks), Settings of an Access Point to connect

For details of Auto mode, see **5.2 Automatic Operating Mode Change**.

5-1-1. Mesh Point (MP) Mode

MNS-300EM operates in MP mode when the operating mode is changed to **Mesh**. The Mesh function starts and MNS-300EM can join the Mesh network.

Mesh Networks

The Mesh network has the following characteristics:

- Mesh compatible devices (Mesh devices) connect with each other without Access Points, and establish a network.
- As a wireless distance can be expanded by relay of radio waves, wide range communication is possible.
- In the Mesh network, Mesh devices select a best route for relay. In the example below, if the MNS-300EM embedded device (2) malfunctions when Route (1) is used, other Mesh devices will rebuild Route (2) to continue the communication.

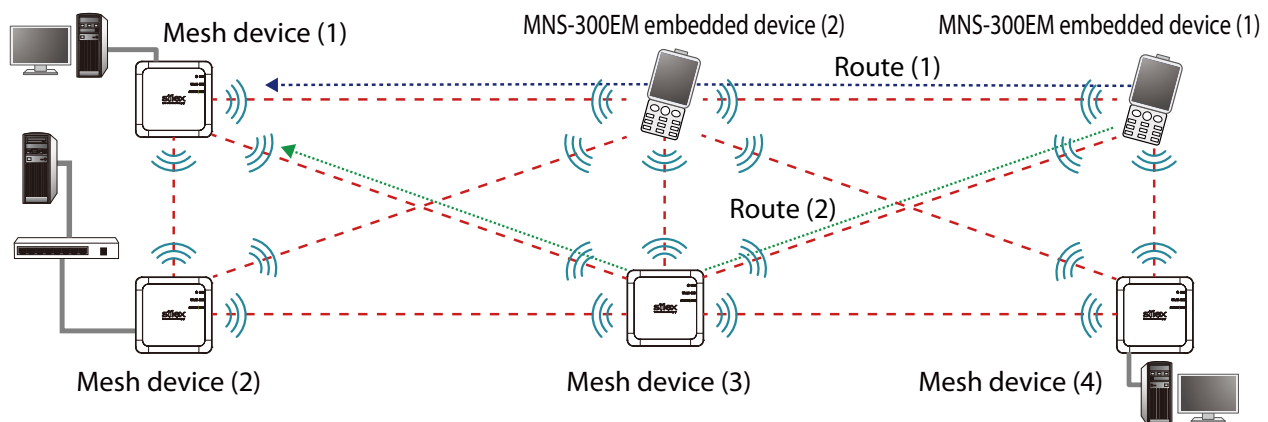

- MNS-300EM cannot connect to an Access Point when it is operating in MP mode. Also, Smart Wireless Setup cannot be executed.

Mesh Profiles

MNS-300EM saves the Mesh network setting as Mesh profile. Up to five Mesh profiles can be saved. In MP mode, choose one of Mesh profiles to use.



TIP

- When MNS-300EM is operating in MP mode, it keeps operating with the specified Mesh profile settings regardless of a nearby wireless environment. When you want to use the other Mesh profile, it needs to be manually changed.



Note

- MNS-300EM switches multiple Mesh profiles during the operation in AUTO mode. For more details, see **5-2. Automatic Operating Mode Change**.

MP Mode Setting

1. Access the MNS-300EM's Web page using the Web browser.



Note

- For details, see **How to Access the MNS-300EM's Web Page**.

2. Click **Mesh Mode** from the page menu.

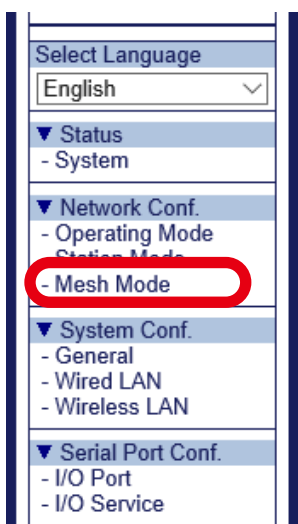

5. Repeat the step 2-3 to change the other Mesh profiles. When the configuration is finished for all Mesh profiles, click **Operating Mode** from the page menu.

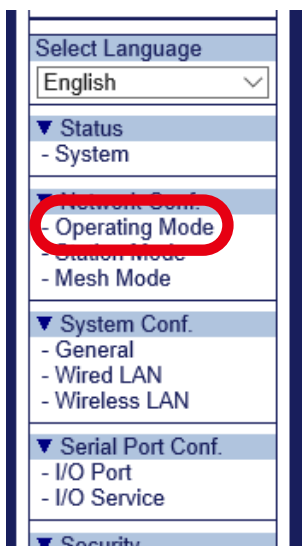

6. Change the operating mode to **Mesh** (1), choose the Mesh profile to use (2) and click **Submit** (3).



7. Restart MNS-300EM to take effect of the settings.

Click **Restart** from the page menu, and click **Yes** in the displayed page.

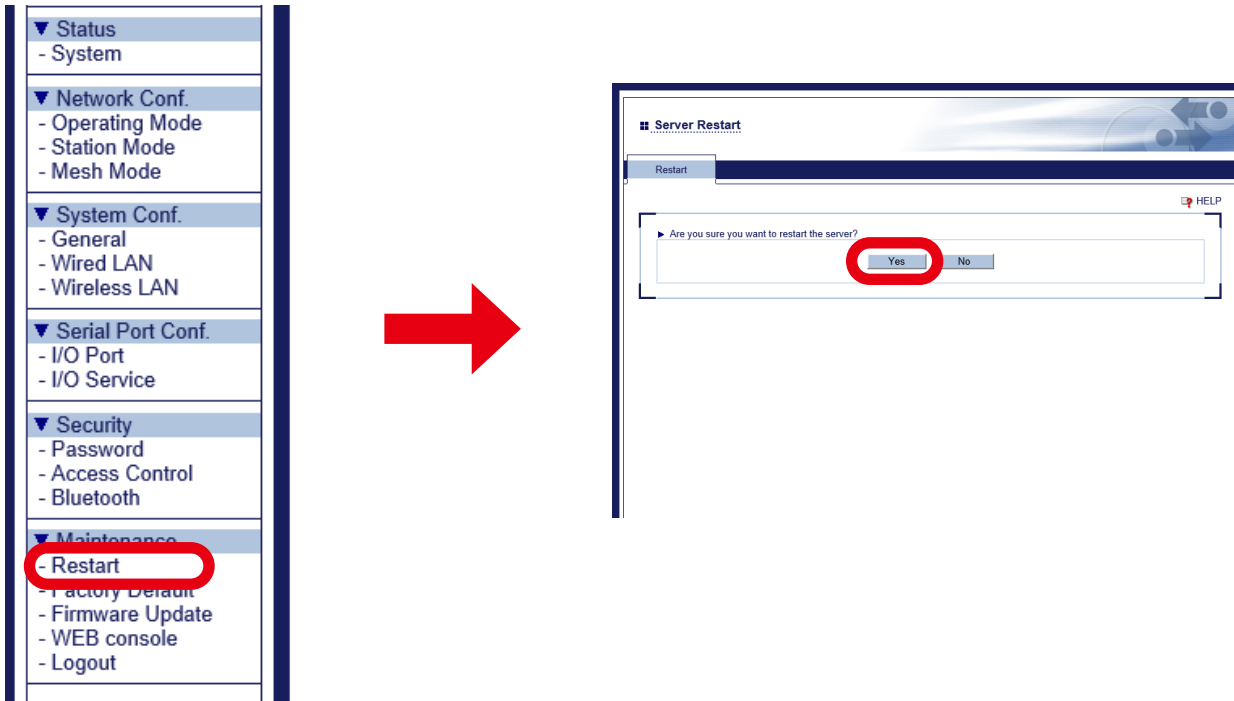

Now, the MP mode settings are completed.

5-1-2. Station (STA) Mode

MNS-300EM operates in STA mode when the operating mode is changed to **Station**.

When STA mode is on, MNS-300EM can be connected to Access Point. Also, the Smart Wireless Setup can be used for quick wireless configuration.



TIP

- When STA mode is on, MNS-300EM can not be connected to a Mesh network.
- Unlike MP mode, it is impossible to save multiple profiles when STA mode is on.



Note

- When the Mesh network includes MAP, MNS-300EM can connect to MAP as a wireless client device to communicate with devices in the Mesh network.
- For details on the smart wireless setup function, see **6. Smart Wireless Setup**.

STA Mode Setting

1. Access the MNS-300EM's Web page using the Web browser.



Note

- For details, see **How to Access the MNS-300EM's Web Page**.

2. Click **Station Mode** from the page menu.

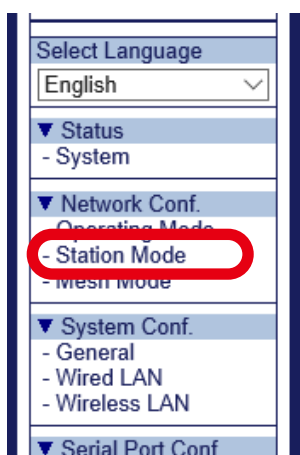

3. Configure each setting according to the Access Point to connect (1) and click **Submit** (2).

Station Mode Configuration Smart Wireless Setup

WIRELESS LAN Basic Configuration

Name	Value
SSID	seeserv
Network Authentication	Open

WEP Configuration

Name	Value
WEP	OFF

Bridge Configuration

Name	Value
Bridge Mode	Disable

TCP/IP Configuration

Name	Value
DHCP	AUTO
IP Address	169.254.111.111
Subnet Mask	255.255.0.0
Default Gateway	0.0.0.0
DNS Server (Primary)	0.0.0.0
DNS Server (Secondary)	0.0.0.0

Submit



Note

• For details on each configuration item, see **A. Configuration Items on Web Page**.

4. Click **Operating Mode** from the page menu.

Select Language

English

▼ Status

- System

▼ Network Conf.

- **Operating Mode**
- Station mode
- Mesh Mode

▼ System Conf.

- General
- Wired LAN
- Wireless LAN

▼ Serial Port Conf.

5. Change the operating mode to **Station** (1) and click **Submit** (2).

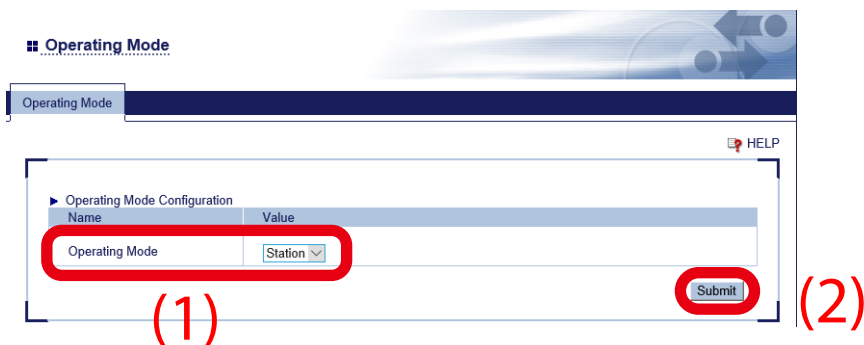

6. Restart MNS-300EM to take effect of the settings. Click **Restart** from the page menu and click **Yes** in the displayed page.

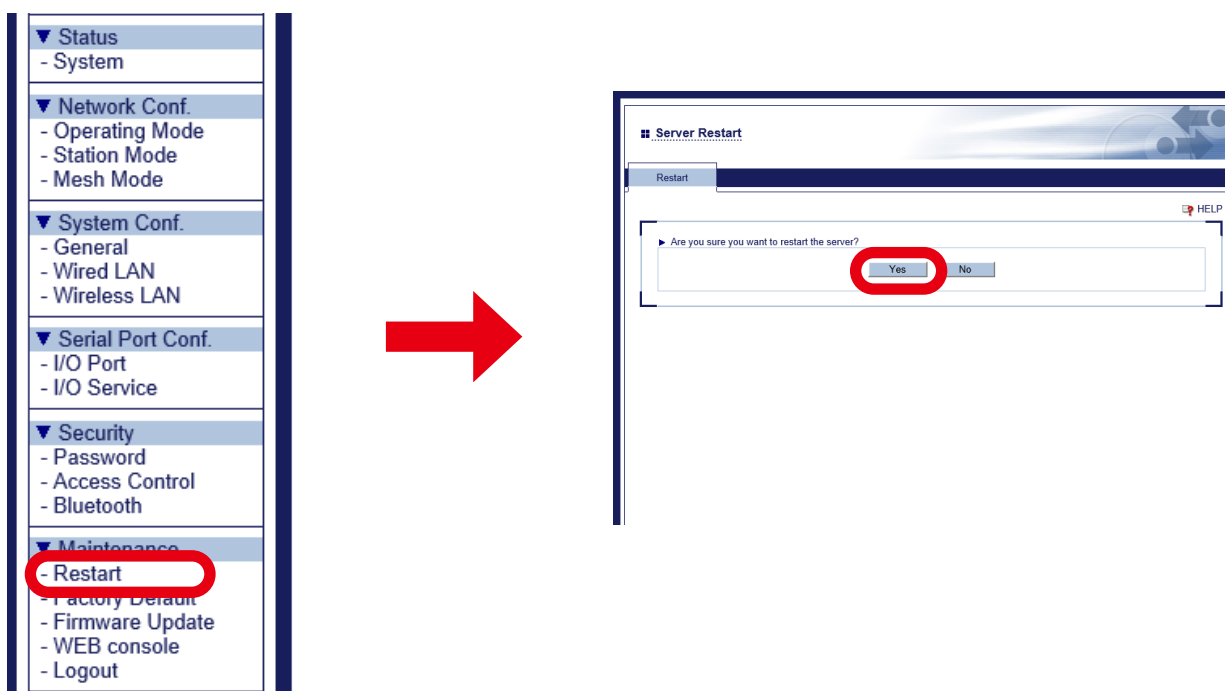

Now, the STA mode settings are completed.

5-2. Automatic Operating Mode Change

5-2-1. Auto Mode

When the operation mode is Auto mode, the operating mode changes according to the surrounding wireless environment. When MNS-300EM connects to a wireless device, it changes the operating mode according to the device with a highest signal strength among nearby MP (MAP) and Access Points. One of the five Mesh profiles can be selected when MP mode is on, while multiple Mesh profiles can be selected and switched according to the wireless environment when Auto mode is on. Even when multiple Mesh networks exist in your environment, the destination device can be switched.

The table below shows how MNS-300EM changes the operating mode.

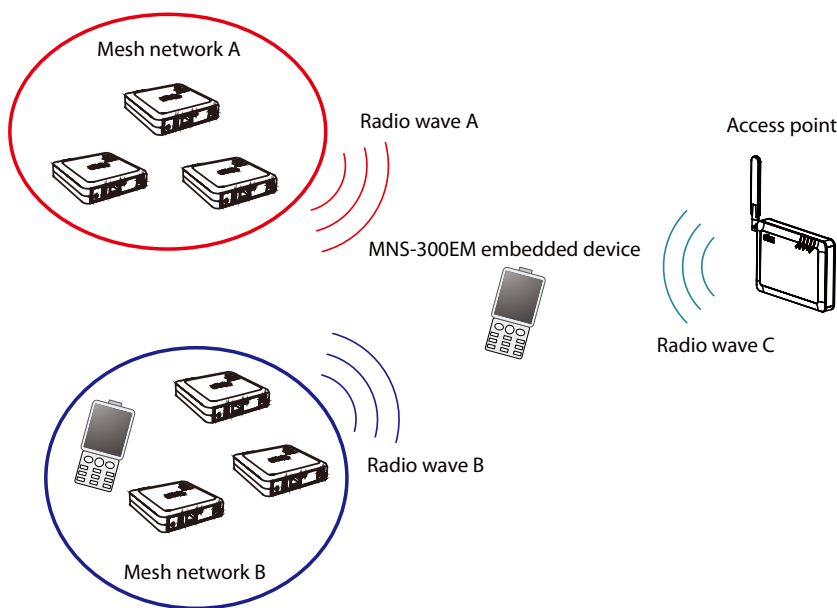

Highest signal strength	Operating mode	Destination	Mesh profile to use
Radio wave A	Mesh	Mesh network A	Mesh profile with Mesh network A setting
Radio wave B	Mesh	Mesh network B	Mesh profile with Mesh network B setting
Radio wave C	Station	Access Point	-

When Auto mode is on, the TCP/IP setting of MNS-300EM (e.g. IP address, etc.) is also changed. By defaults, the TCP/IP setting for Station mode is used, but it is updated to the one of each Mesh profile once MNS-300EM is connected to MP (MAP). This update will run only for wireless connection, and does not run for wireless disconnection.



TIP

- When the bridge function is disabled and the mode is changed from AUTO to STA, the wired communication will be disabled.



Note

- When no MP/MAP or Access Point is found, MNS-300EM will keep searching them until it can connect.
- After MNS-300EM is turned on, it operates in MP mode to search for the MP/MAP and Access Point to connect. If the MP/MAP is found as destination, MNS-300EM will stay in MP mode, and if the Access Point is found as destination, MNS-300EM will switch to STA mode.
- When the push button (SW2) on MNS-300EM-EVK is pressed down for 4 seconds or less, MNS-300EM will immediately start searching MP (MAP) or Access Points. If MP (MAP) or Access Point is connected then, it will be disconnected.

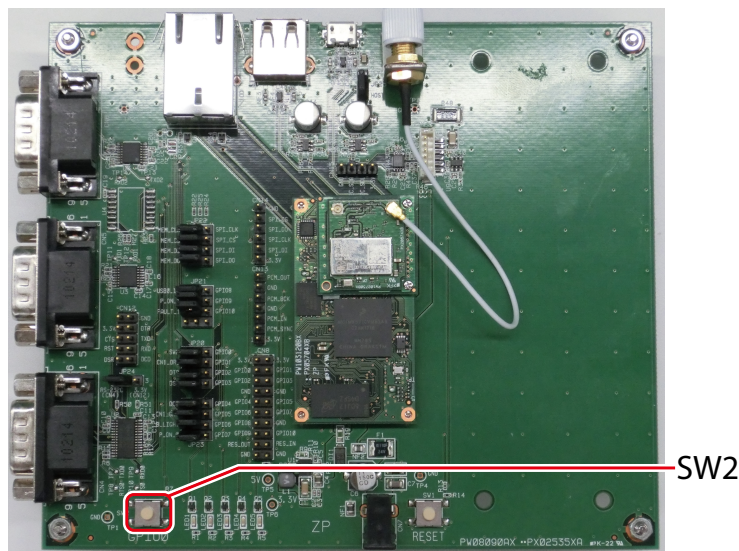

5-2-2. Auto Mode Setting

1. Access the MNS-300EM's Web page using the Web browser.



• For details, see [How to Access the MNS-300EM's Web Page](#).

Note

2. Click **Mesh Mode** from the page menu.

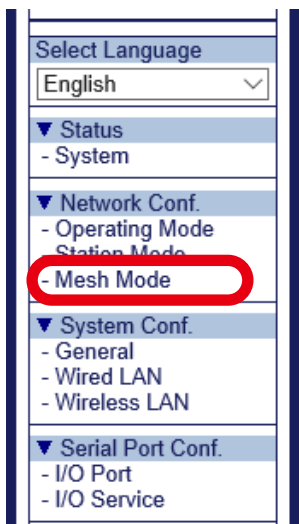

3. Click a tab of the Mesh profile to change.

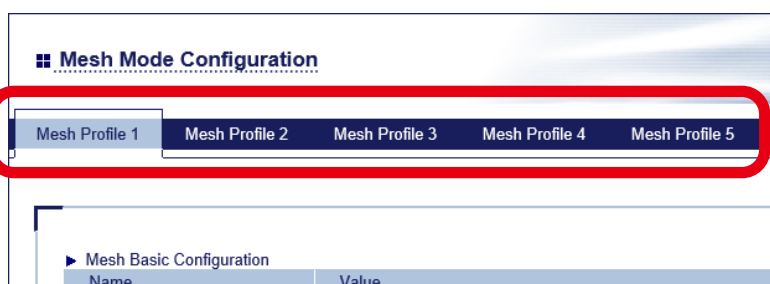

4. The selected Mesh profile page shows up.
 Configure each setting according to the Mesh network to connect (1) and click **Submit** (2).

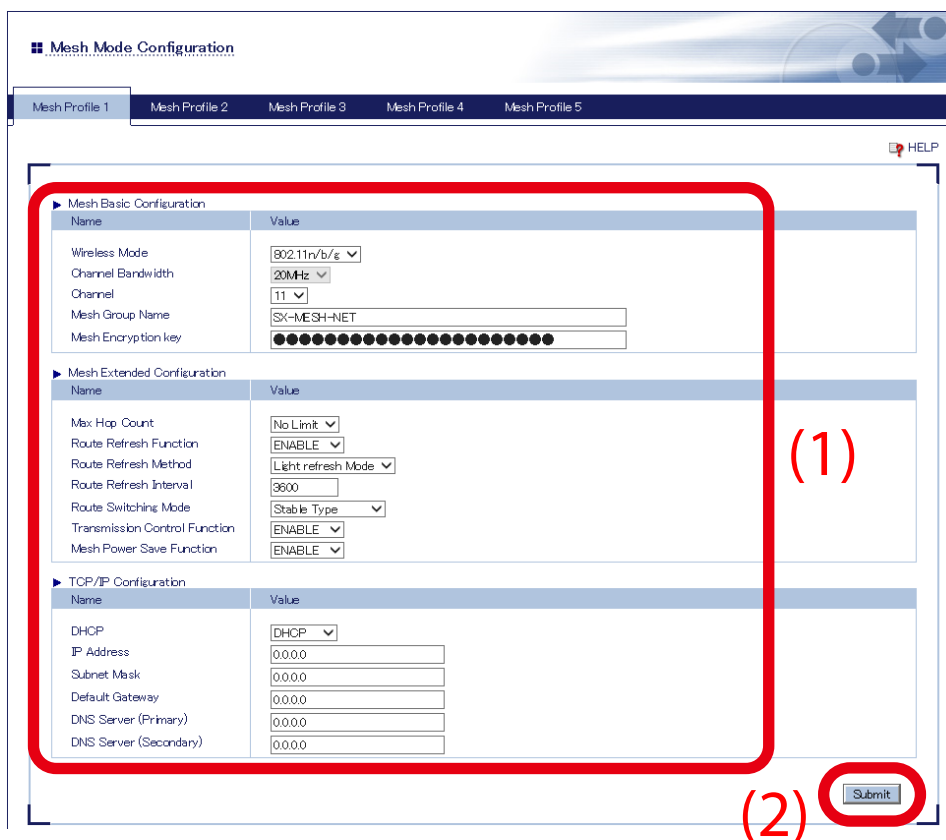

TIP

- The setting of **Mesh Basic Configuration** needs to match that of the Mesh network to connect.
- If the setting of **Mesh Extended Configuration** differs from that of the Mesh network to connect, the communication may become unstable.
- The channel bandwidth of **802.11n/b/g** is fixed to **20MHz**.



Note

- It is possible to save the IP address setting to the Mesh profile.
- For details on each configuration item, see **A. Configuration Items on Web Page**.

Repeat the step 3-4 to change other Mesh profiles.

5. When configuration is finished for all Mesh profiles, click **Station Mode** from the page menu.

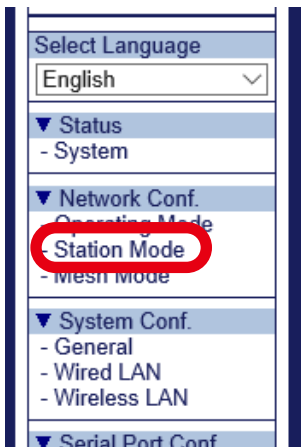

6. Configure each setting according to the Access Point to connect (1) and click **Submit** (2).

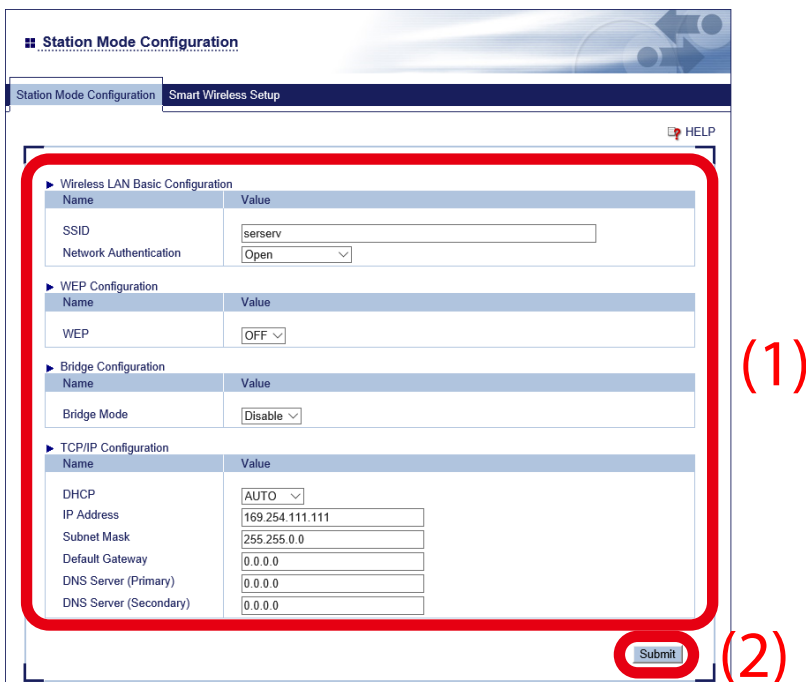

• For details on each configuration item, see **A. Configuration Items on Web Page**.

Note

7. Click **Operating Mode** from the page menu.

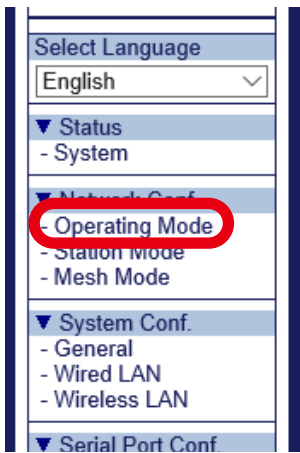

8. Change the operating mode to **Auto** (1), choose one or more Mesh profiles to use (2) and click **Submit** (3).

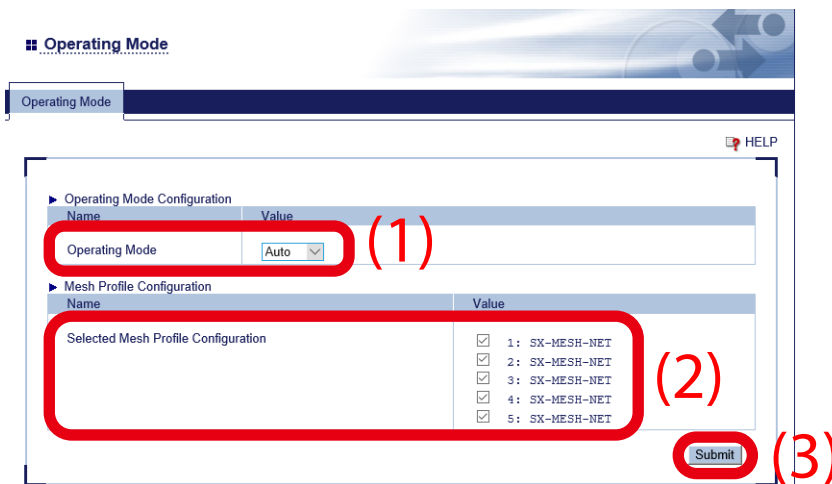

9. Restart MNS-300EM to take effect of the settings.

Click **Restart** from the page menu, and click **Yes** in the displayed page.

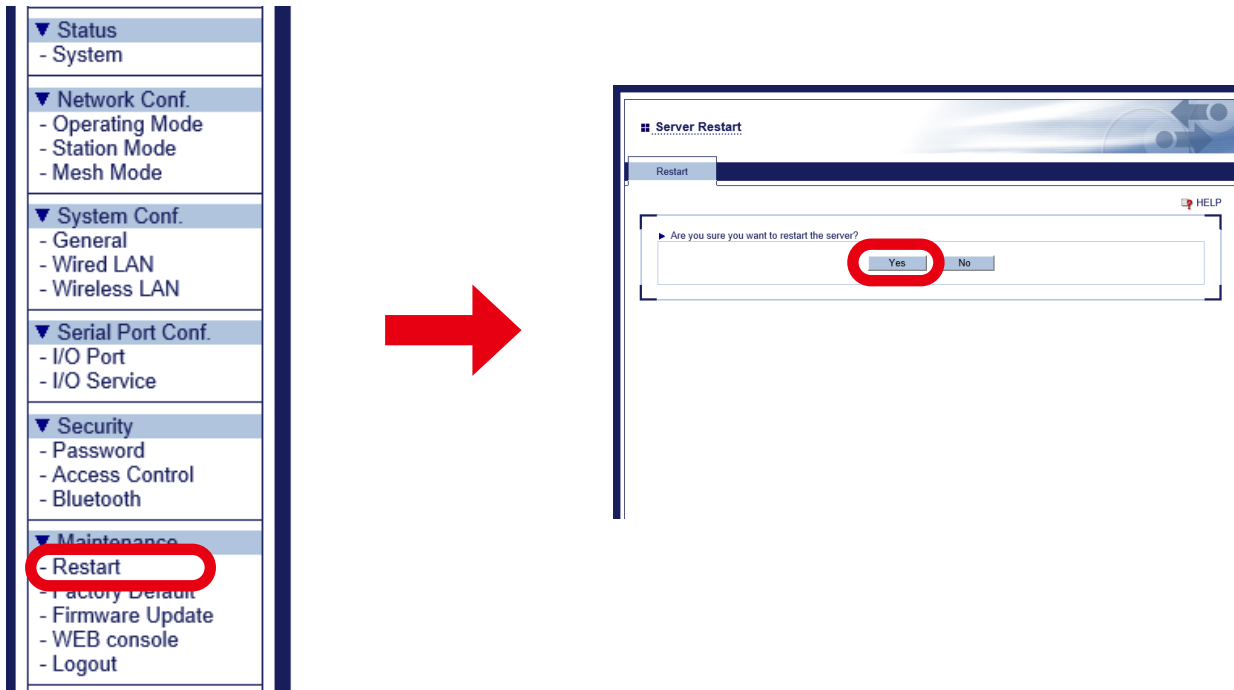

Now, the Auto mode settings are completed.

(Blank Page)

6. Smart Wireless Setup

MNS-300EM supports a quick wireless configuration method, "Smart Wireless Setup".

When your Access Point supports WPS (Wi-Fi Protected Setup), the wireless setting of MNS-300EM can easily be configured using this function.

The Web page or command console can be used to execute Smart Wireless Setup.

6-1. Features

Smart Wireless Setup of MNS-300EM has a function equivalent to WPS2.0 and can be used for STA mode only.

Smart Wireless Setup also supports a combination of authentication/encryption that is not supported by configuration via the Web page or command console. After Smart Wireless Setup is finished successfully, MNS-300EM operates with the acquired setting, and such setting will remain even after MNS-300EM is restarted.

If the acquired setting includes a combination of authentication/encryption that cannot be configured via the Web page or command console of MNS-300EM, such setting is replaced to appropriate ones to take effect on the product configuration.

The table below shows the example.

Obtained setting	Operation	Setting to be saved
WPA-PSK	WPA-PSK TKIP/AES	WPA-PSK TKIP/AES
WPA2-PSK TKIP or AUTO	WPA2-PSK + TKIP/AES	WPA2-PSK AES
WPA/WPA2-PSK + TKIP or AUTO	WPA2-PSK + TKIP/AES	WPA2-PSK AES
WPA/WPA2-PSK + AES	WPA2-PSK + AES	WPA2-PSK AES



TIP

- The IEEE802.1x setting is not supported by Smart Wireless Setup.
- If an SSID, authentication method, encryption mode, or pre-shared key is changed, the setting state made by Smart Wireless Setup will be discarded, and MNS-300EM will use its own configuration.

6-2. Configuration Using Web Page

6-2-1. Push-Button Method

1. Access the MNS-300EM's Web page using the Web browser.



• For details, see **How to Access the MNS-300EM's Web Page**.

Note

2. Click **Station Mode** from the page menu.

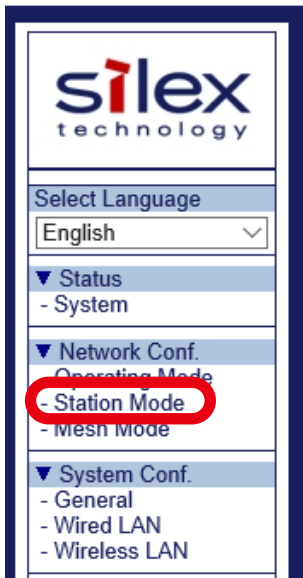

3. Click **Smart Wireless Setup** tab.

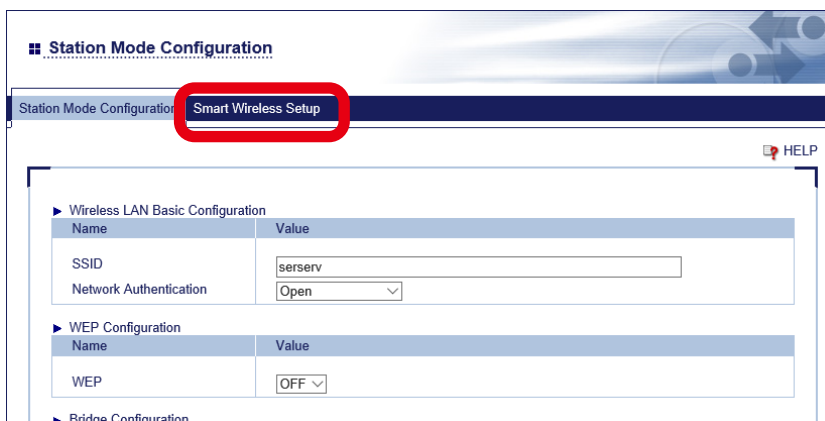

4. Push the WPS button on the Access Point, and see if the Access Point is waiting for connection.



Note

- The name, position and shape of the WPS button will differ for each Access Point. For details, see the instruction manual that comes with the Access Point.
- Use only one Access Point in this configuration method. When multiple Access Points are waiting for connection, MNS-300EM fails to connect.

5. Click **Execute** at **Push Button** on the Web page.

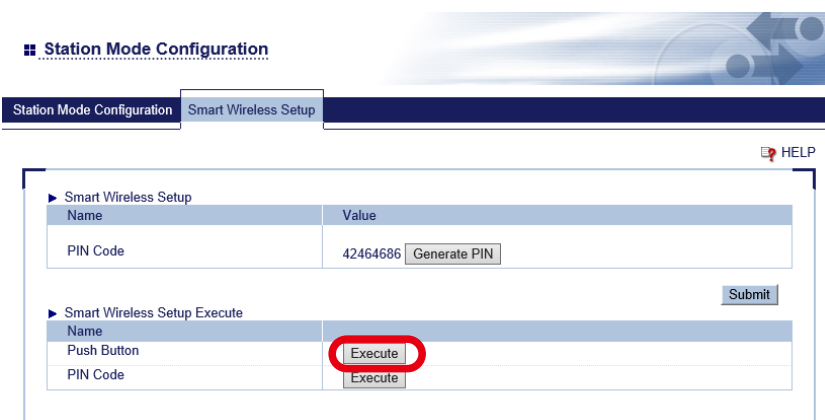

6. Smart Wireless Setup begins.

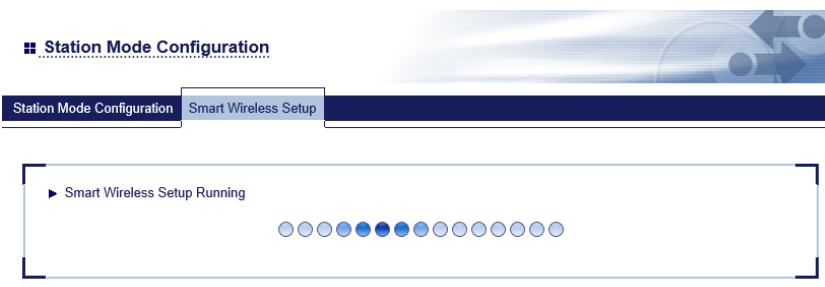

Note

- It may take a while to complete the wireless configuration (up to 2 minutes).

7. MNS-300EM operates with the wireless settings that can communicate with the Access Point after configuration is finished.

6-2-2. Pin-Code Method

1. Access the MNS-300EM's Web page using the Web browser.



• For details, see **How to Access the MNS-300EM's Web Page**.

Note

2. Click **Station Mode** from the page menu.

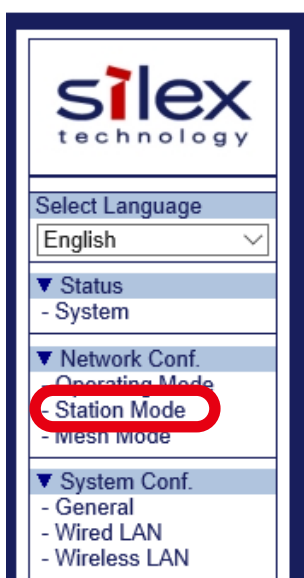

3. Click **Smart Wireless Setup** tab.

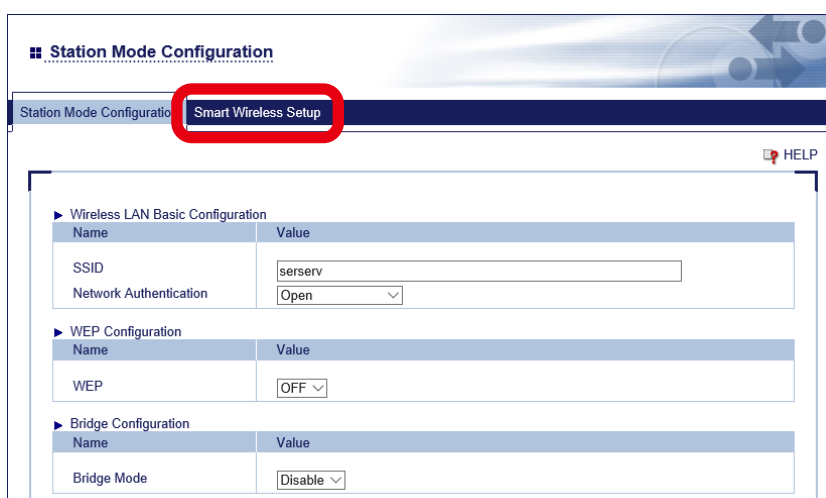

4. Check the PIN code in the page. Keep this page displayed as it will need to be referred again in the following steps.

Station Mode Configuration

Station Mode Configuration Smart Wireless Setup

HELP

Smart Wireless Setup

Name	Value
PIN Code	42464686 Generate PIN

Submit

Smart Wireless Setup Execute

Name	
Push Button	Execute
PIN Code	Execute



- To change the PIN code, click **Generate PIN** to issue new PIN code.

Note

5. Open another page to access the Access Point's Web page. Enter the PIN code of MNS-300EM (see the step 4), and start WPS connection.

6. Go back to the MNS-300EM's Web page and click **Execute** at **PIN Code**.

Station Mode Configuration

Station Mode Configuration Smart Wireless Setup

HELP

Smart Wireless Setup

Name	Value
PIN Code	42464686 Generate PIN

Submit

Smart Wireless Setup Execute

Name	
Push Button	Execute
PIN Code	Execute

7. Smart Wireless Setup begins.

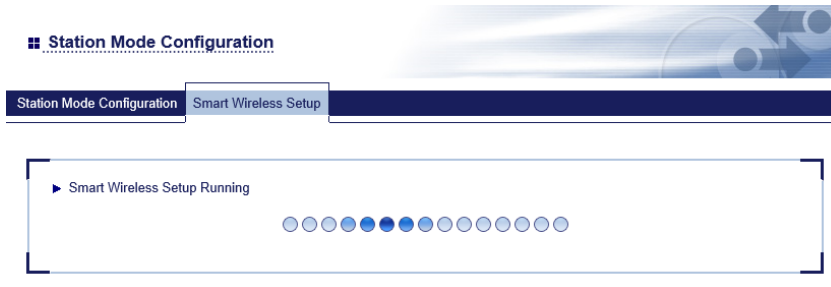

8. MNS-300EM operates with the wireless settings that can communicate with the Access Point after configuration is finished.

6-3. Configuration Using Command Console

6-3-1. Push-Button Method

1. Access the command console of MNS-300EM. (For details, see **3-4-2. How to Access Command Console**).
2. Turn on the Access Point supporting WPS, and press the WPS button.
See if the Access Point is waiting for connection.



Note

- The name, position and shape of the WPS button will differ for each Access Point. For details, see the instruction manual that comes with the Access Point.
- Use only one Access Point in this configuration method. When multiple Access Points are waiting for connection, MNS-300EM fails to connect.

3. Execute the following command on the command console.

SET NW SWSPBC

Executes the push-button method.

4. MNS-300EM operates with the wireless settings that can communicate with the Access Point after configuration is finished.

6-3-2. Pin-Code Method

1. Access the command console of MNS-300EM. (For details, see **3-4-2. How to Access Command Console**).
2. Turn on the Access Point supporting WPS, and prepare for configuration using the PIN-code.
3. Execute the following commands on the command console.

SET NW SWSPINCODE

Issues PIN code.

SH NW SWSPINCODE

Checks the current PIN code.

SET NW SWSPIN

Executes the PIN-code method.

4. Enter the PIN code of MNS-300EM at the Access Point, and start the PIN-code method.



Note

- For detailed procedure for configuration, see the instruction manual that comes with the Access Point.

5. MNS-300EM operates with the wireless settings that can communicate with the Access Point after configuration is finished.

(Blank Page)

7. Serial Device Communication

7-1. Ecable Mode

For some applications, connection needs to be made from MNS-300EM to PC for communication. The connection can be established from MNS-300EM using the Ecable mode.

7-1-1. Communication Setting

Configure the MNS-300EM setting to use Ecable mode.

1. Access the MNS-300EM's Web page using the Web browser.



• For details, see **How to Access the MNS-300EM's Web Page**.

Note

2. Click **I/O Port** from the page menu.

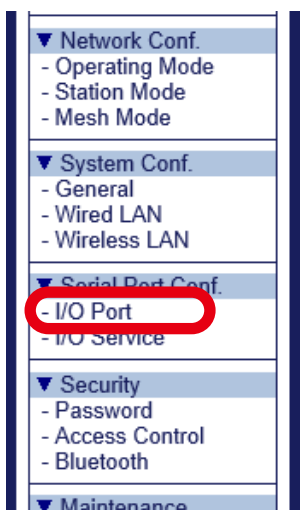

3. Configure the communication setting at **I/O Port Configuration** according to the serial device to connect (1).

- Baud rate
- Bits per character
- Stop bits
- Parity
- Flow control

Choose **Enabled** for **Ecable Mode** at **Ecable Mode Configuration**. Enter the IP address of the destination device for **Destination IP Address**, the port number for **Destination Port** (2), and click **Submit** (3).

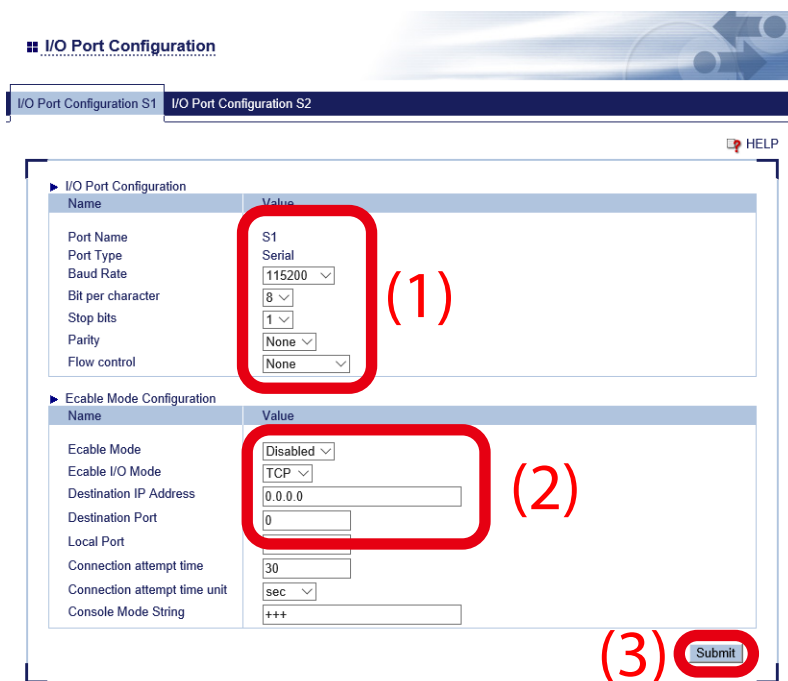

4. Restart MNS-300EM to take effect of the settings.

Click **Restart** from the page menu, and click **Yes** in the displayed page.

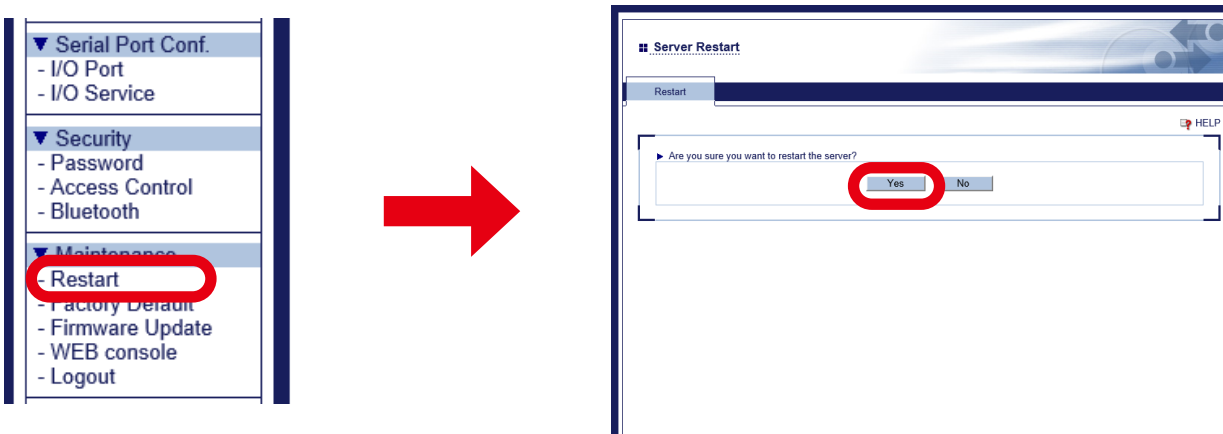

Now, Ecable settings are completed.

7-2. Raw TCP Port

MNS-300EM can send/receive the serial port data via a transparent TCP port over the TCP/IP communication. Open a connection to the TCP port of MNS-300EM using the socket API (or equivalent API).

To use the function, connect to the default port number.

The default port numbers are as follows:

- Serial Port 1: 9100 or 3001
- Serial Port 2: 9101 or 3002

To access a serial device using modem control signals from PC, use TCP port# 9200 (Serial Port 1) or 9201 (Serial Port 2). (Port# 9200 and 9201 support RFC2217.)

7-2-1. Communication Setting

Configure the MNS-300EM settings to make communication over Raw TCP port.

1. Access the MNS-300EM's Web page using the Web browser.



• For details, see **How to Access the MNS-300EM's Web Page**.

Note

2. Click **I/O Port** from the page menu.



3. Configure the communication setting at **I/O Port Configuration** according to the serial device to connect (1), and click **Submit** (2).

- Baud rate
- Bits per character
- Stop bits
- Parity
- Flow control

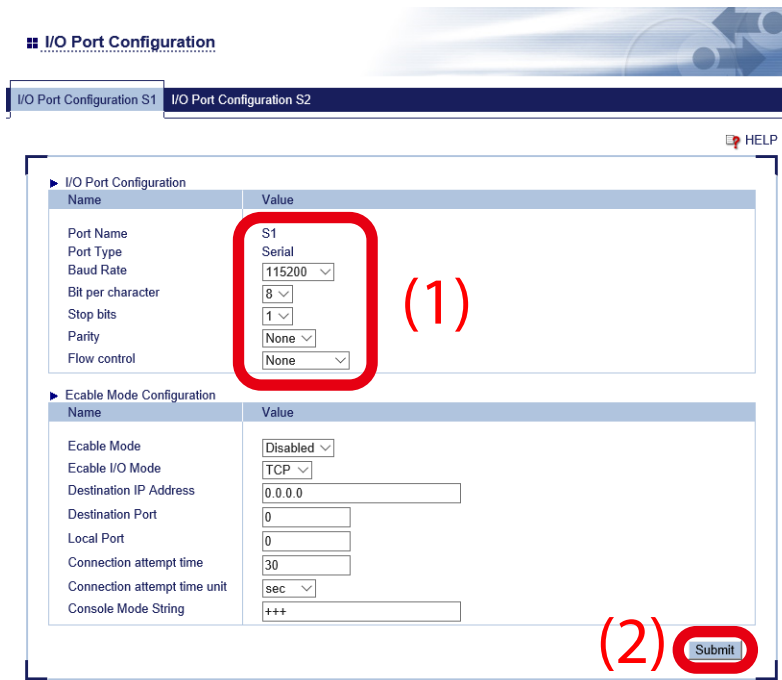

I/O Port Configuration

I/O Port Configuration S1 | I/O Port Configuration S2

HELP

Name	Value
Port Name	S1
Port Type	Serial
Baud Rate	115200
Bit per character	8
Stop bits	1
Parity	None
Flow control	None

Name	Value
Ecable Mode	Disabled
Ecable I/O Mode	TCP
Destination IP Address	0.0.0.0
Destination Port	0
Local Port	0
Connection attempt time	30
Connection attempt time unit	sec
Console Mode String	+++

(2) Submit

4. Click **I/O Service** from the page menu.



- ▼ Network Conf.
 - Operating Mode
 - Station Mode
 - Mesh Mode
- ▼ System Conf.
 - General
 - Wired LAN
 - Wireless LAN
- ▼ Serial Port Conf.
 - I/O Port
 - I/O Service
- ▼ Security
 - Password
 - Access Control
 - Bluetooth
- ▼ Maintenance

5. Enter the TCP port number to use for the application in **Raw TCP Port** (1), and click **Submit** (2).

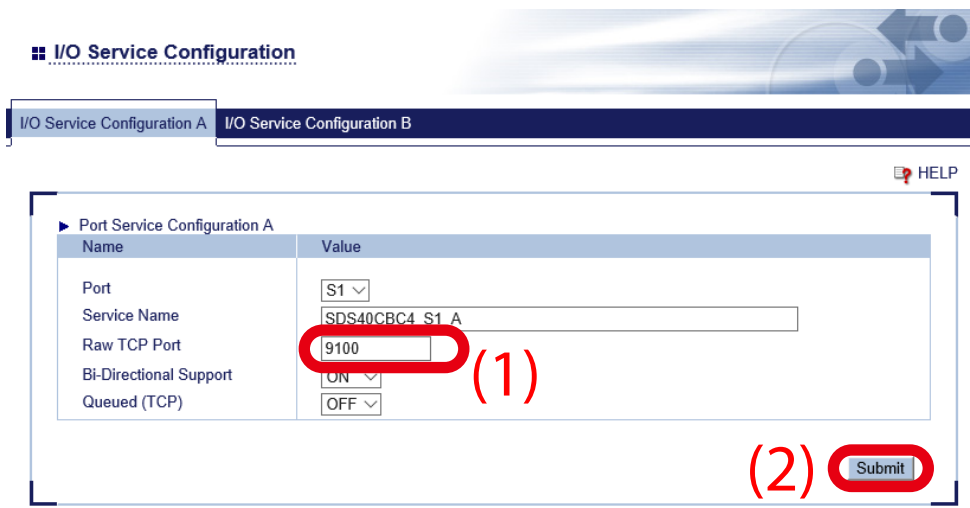

6. Restart MNS-300EM to take effect of the settings.
Click **Restart** from the page menu, and click **Yes** in the displayed page.

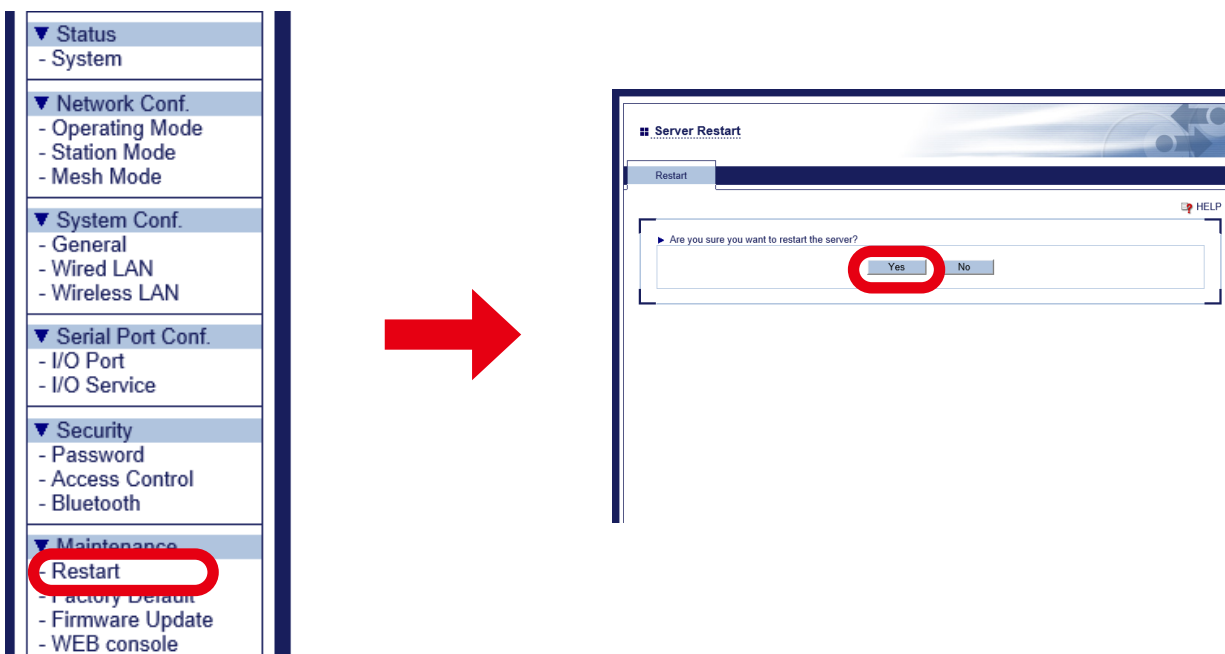

Now, the settings are completed.

8. GPIO Settings

This chapter describes the special functions of GPIO signal lines.

8-1. GPIO Special Functions

MNS-300EM has 11 GPIO (General Purpose I/O) signal lines.

GPIO signal lines can individually be used for Input, Output and special functions.

By defaults, 5 GPIO signal lines are assigned for the special functions.

The following table shows the outline of special functions.

GPIO	i.MX6ull	I/O	Drive hi/lo(mA)	Silex's function overview (3.3 VDC level)
GPIO0/TEST_N	GPIO1_0	I	-5/3.8	Pushbutton switch 1 = off, 0 = Switch depressed
GPIO1/SLED	GPIO4_19	O	-5/3.8	Status LED 1 = off, 0 = Illuminated
GPIO2/UART2_DTR	GPIO4_21	I/O	-5/3.8	Output: UART2 DTR signal
GPIO3/UART2_DSR	GPIO4_20	I/O	-5/3.8	Input: UART2 DSR signal
GPIO4/UART2_DCD	GPIO4_22	I/O	-5/3.8	Input: UART2 DCD signal
GPIO5	GPIO1_27	I/O	-5/3.8	
GPIO6	GPIO4_23	I/O	-5/3.8	
GPIO7	GPIO1_26	I/O	-5/3.8	
GPIO8	GPIO4_24	I/O	-5/3.8	
GPIO9	GPIO1_19	I/O	-5/3.8	
GPIO10	GPIO1_18	I/O	-5/3.8	

Use the command console to set the GPIO input/output direction.

For details on the GPIO commands, see **MNS-300EM Command Manual**.

8-2. How to Enable GPIO Special Functions on EVK

GPIO special functions can be enabled on MNS-300EM-EVK. The special functions are assigned to JP20, JP23 and JP21 on MNS-300EM-EVK, and one row of jumper pins corresponds to one GPIO signal. The following diagrams show the pin allocation.

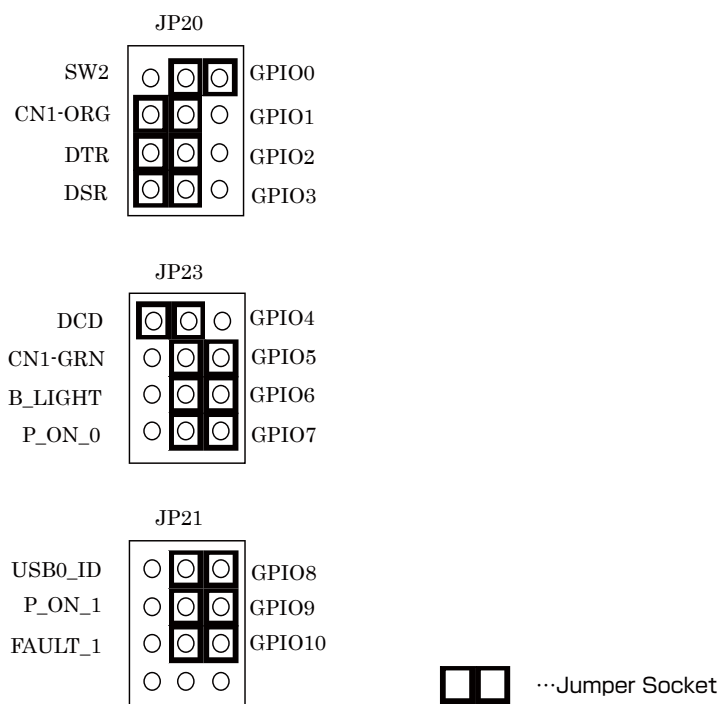

If the left side of jumper pin is shortened with a jumper socket, the special function is enabled. If the right side is shortened, the pin can be used for ordinary GPIO. In the example above, GPIO 0 is the ordinary GPIO, whereas GPIO 1-4 are set to special functions.



TIP

- For the following jumper pins, shorten the pins on the right side as shown on above image.

JP23 : GPIO5, GPIO6, GPIO7

JP21 : GPIO8, GPIO9, GPIO10

(Blank Page)

9. Security Function

This chapter describes the MNS-300EM's security functions.

9-1. Protocol Filter

The following shows how to stop unused services to stop opening unnecessary ports.

1. Access the MNS-300EM's Web page using the Web browser.



• For details, see **How to Access the MNS-300EM's Web Page**.

Note

2. Click **Access Control** from the page menu.

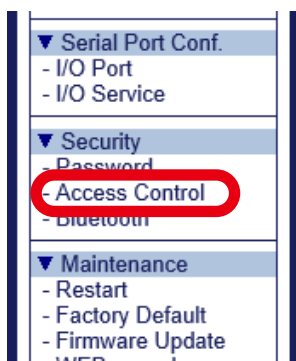

3. Turn on/off a protocol filter for each (1), and click **Submit** (2).

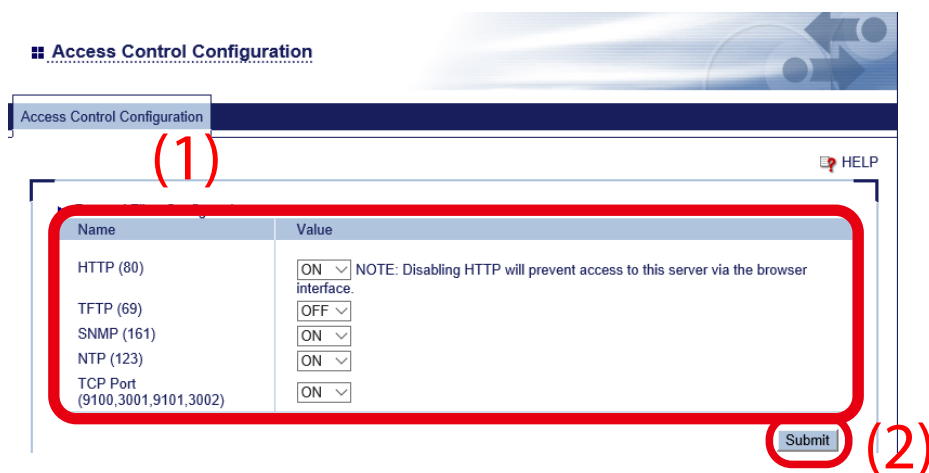

4. Restart MNS-300EM to take effect of the settings.

Click **Restart** on the page menu, and click **Yes** in the displayed page.

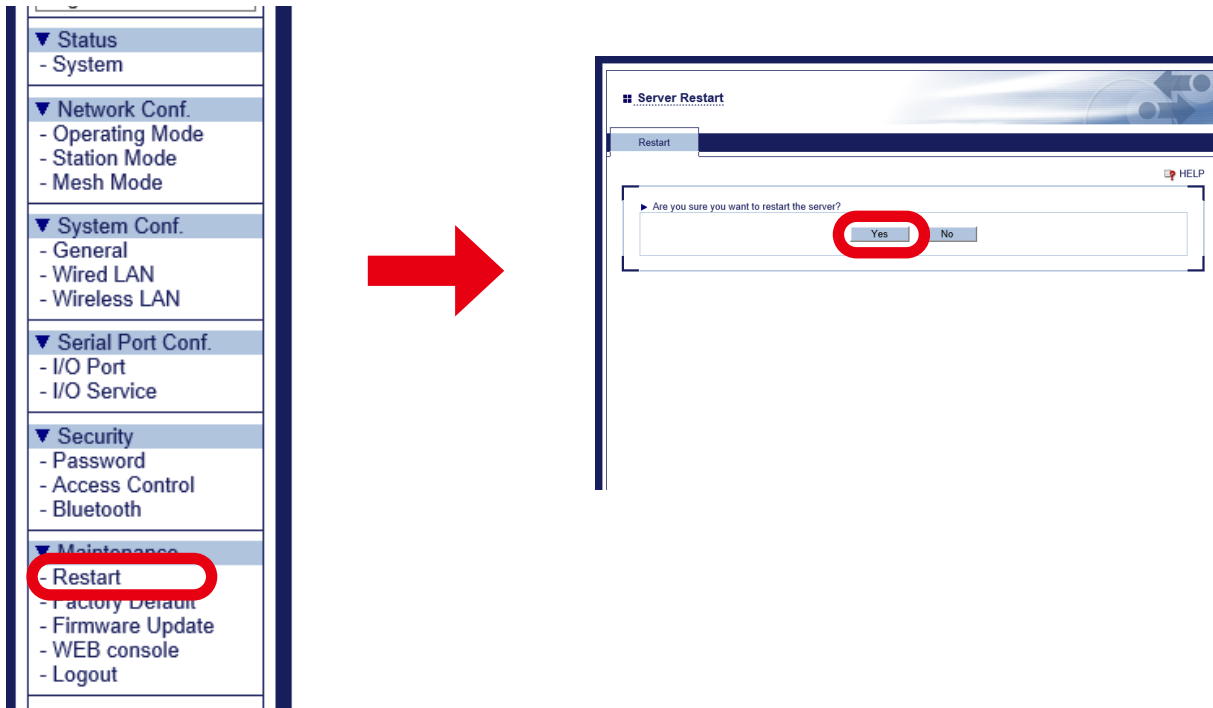

Now, the settings are completed.

9-2. IP Address Filter

If the IP address filter function is used, only the registered IP address can be accessed to MNS-300EM. Up to 4 ranges of IP address can be registered.

The following example shows how to allow an access from the IP address range "172.25.72.10" - "172.25.72.20".



- When the IP address range is not registered, MNS-300EM allows an access from any devices.

Note

1. Access the MNS-300EM's Web page using the Web browser.



- For details, see **How to Access the MNS-300EM's Web Page**.

Note

2. Click **Access Control** from the page menu.



3. Enter **Starting Address** and **Ending Address**, and click **Add**. Up to 4 ranges can be registered. In this example, "172.25.72.10" for **Starting Address** and "172.25.72.20" for **Ending Address** are entered.

Access Control Configuration

Access Control Configuration

HELP

Protocol Filter Configuration

Name	Value
HTTP (80)	ON <input type="checkbox"/> NOTE: Disabling HTTP will prevent access to this server via the browser interface.
TFTP (69)	OFF <input type="checkbox"/>
SNMP (161)	ON <input type="checkbox"/>
NTP (123)	ON <input type="checkbox"/>
TCP Port (9100,3001,9101,3002)	ON <input type="checkbox"/>

Submit

IP Filter Configuration.

Name	Value
Starting Address	172.25.72.10
Ending Address	172.25.72.20
Add	

4. The registered address range is shown under **Registered IP Filters**.

Access Control Configuration

Access Control Configuration

HELP

Protocol Filter Configuration

Name	Value
HTTP (80)	ON <input type="checkbox"/> NOTE: Disabling HTTP will prevent access to this server via the browser interface.
TFTP (69)	OFF <input type="checkbox"/>
SNMP (161)	ON <input type="checkbox"/>
NTP (123)	ON <input type="checkbox"/>
TCP Port (9100,3001,9101,3002)	ON <input type="checkbox"/>

Submit

IP Filter Configuration.

Name	Value
Starting Address	0.0.0.0
Ending Address	0.0.0.0
Add	

Registered IP Filters

Name	Value
Remove	172.25.72.10 - 172.25.72.20



TIP

- If an IP address of your PC is not included in the address range under **Registered IP Filters**, your PC will lose an access to MNS-300EM.



Note

- When all the registered ranges are deleted, access of any IP address will be permitted.

5. Restart MNS-300EM to take effect of the settings.

Click **Restart** from the page menu, and click **Yes** in the displayed page.

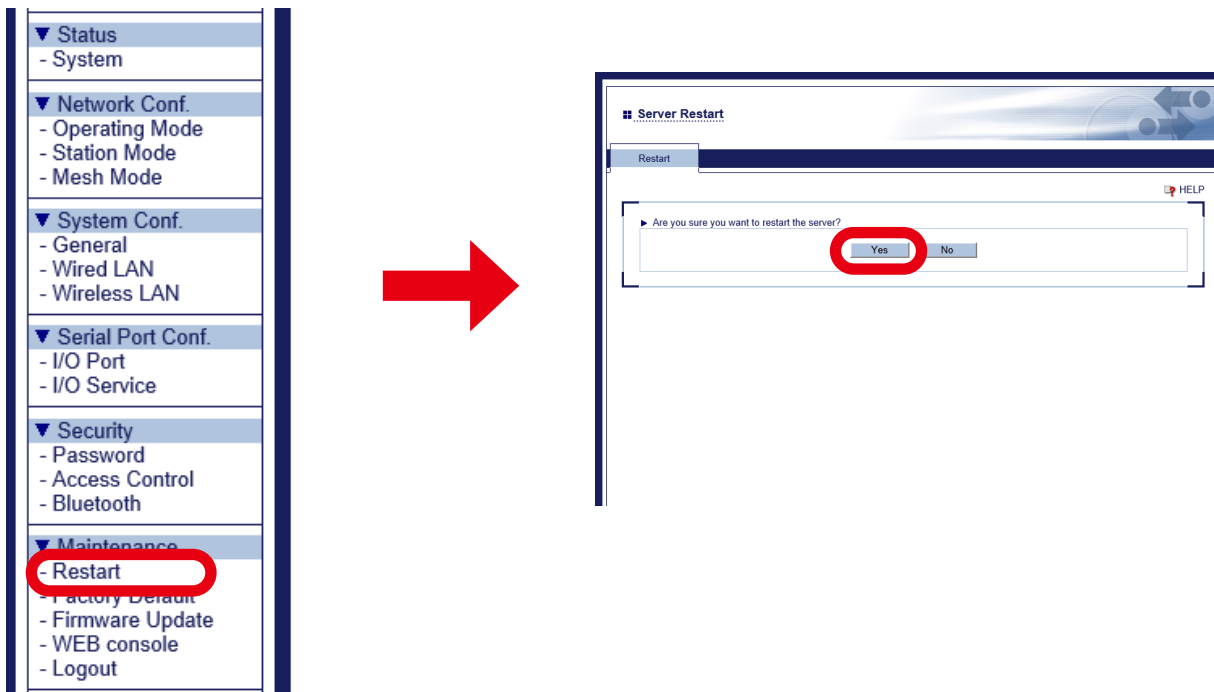

Now, the settings are completed.

10. Maintenance Functions

This chapter describes the maintenance functions.

10-1. Factory Default Configuration

The following shows how to reset MNS-300EM to the factory default settings.

The factory resets can be done by using the Web page or controlling SWITCH signal (GPIO1_0).

10-1-1. Factory Default Configuration Using Web Page

1. Access the MNS-300EM's Web page using the Web browser.



• For details, see **How to Access the MNS-300EM's Web Page**.

Note

2. Click **Factory Default** from the page menu.

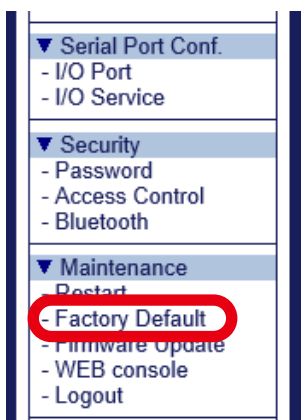

3. The factory reset page appears. Click **Yes**.

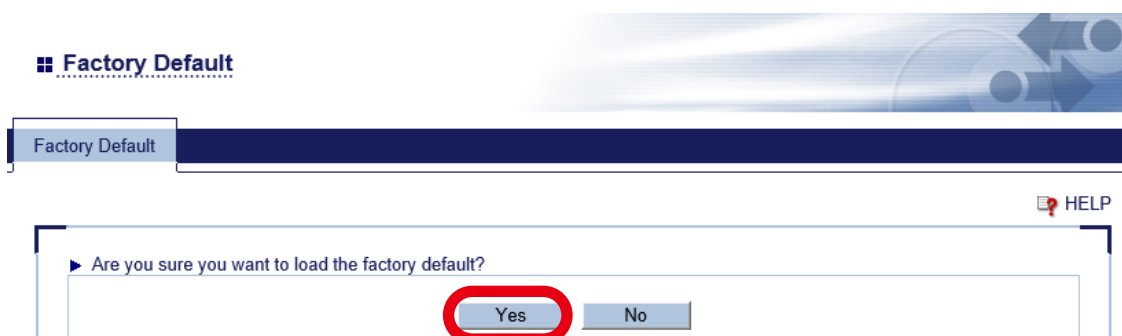

4. The confirmation message shows up. Click **OK**.

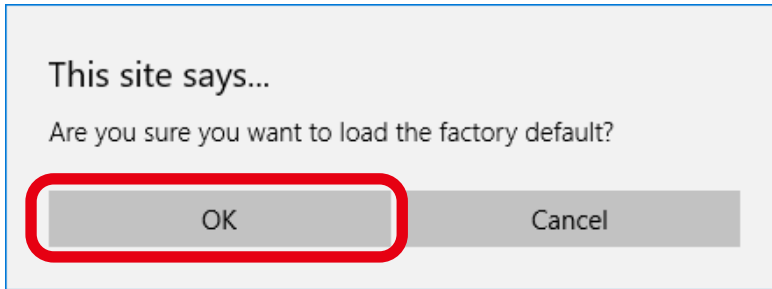

5. The restart confirmation message appears. To restore the factory default settings, click **Yes**.

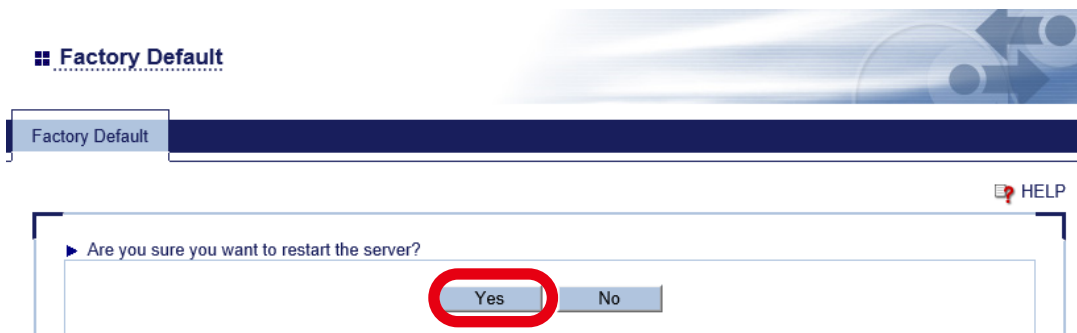

10-1-2. Factory Default Configuration Using Switch Signal

MNS-300EM can be reset to the factory defaults using SWITCH signal (GPIO1_0).

When MNS-300EM-EVK is NOT used:

Keep the signals low for 5 seconds or longer at the GPIO 0 pin on MNS-300EM's interface connector (4.7KΩ pull-up resistor connected to +3.3V DC) to reset MNS-300EM to the factory default settings.



Note

- For details of the interface connector, see **2-2-2. Pin Allocation for Interface Connector** in **MNS-300EM Embedded Manual**.

When MNS-300EM-EVK is used:

When MNS-300EM is turned on, press the push button (SW2) for 5 seconds or more to reset MNS-300EM to the factory default settings.

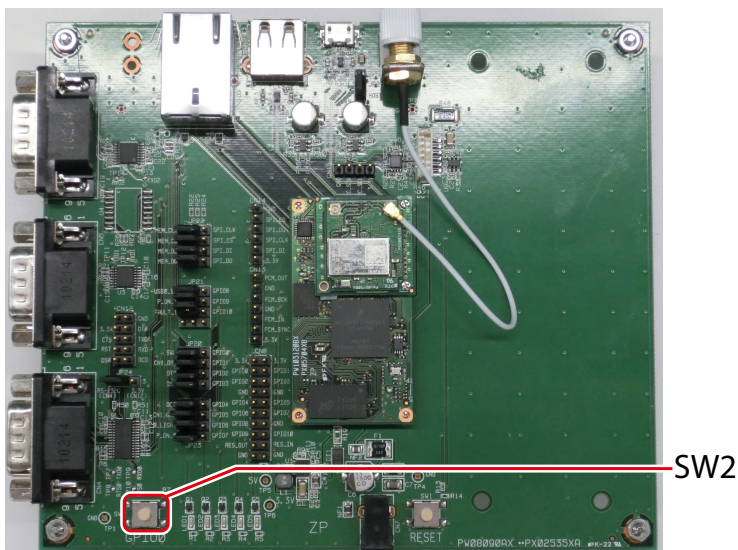

10-2. Firmware Update

Updating the firmware gives new functions to MNS-300EM and resolves particular problems. The firmware can be updated by the following methods.

- MNS-300EM's Web page
- AMC Manager®
- tftp command

10-2-1. How to Download Firmware

Follow the steps below to download the firmware.

1. Access the Silex Technology's homepage (<https://www.silextechnology.com/>).
2. Go to the support section and download the firmware.

10-2-2. Firmware Update Using Web Page

1. Access the MNS-300EM's Web page using the Web browser.



Note

• For details, see **How to Access the MNS-300EM's Web Page**.

- Click **Firmware Update** from the page menu.

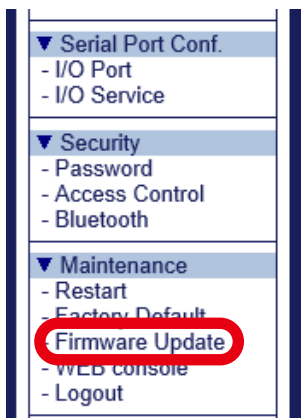

- Click **Browse** to choose the firmware update file (MNS-300EM.bin) saved in the PC (1). Check the proper file name is displayed at **New firmware** (2) and click **Update** (3).

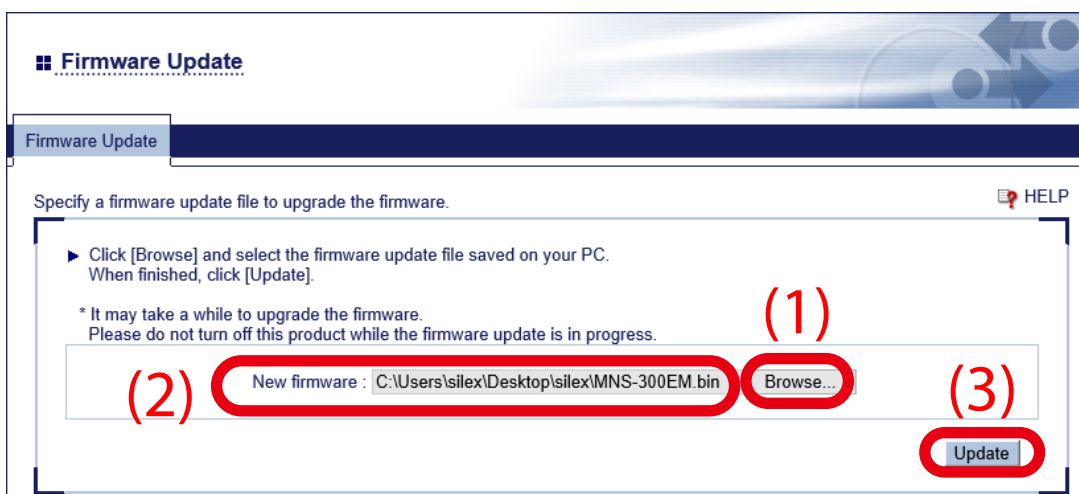

- The confirmation message appears. Click **OK**.

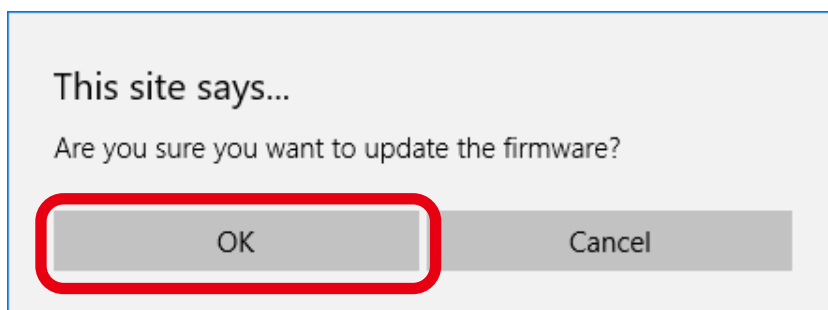

- The firmware update begins. Do not turn off MNS-300EM or close the Web browser until the update is completed.

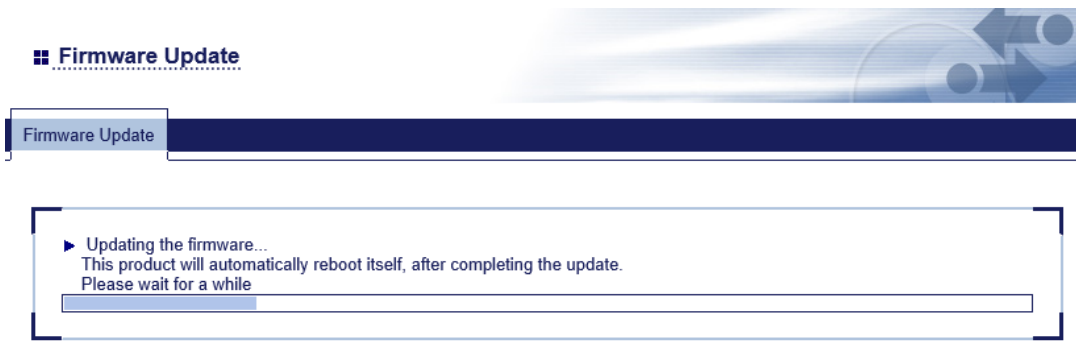

- When the system status page shows up, the update has been completed. See the version information at the left bottom of the Web page and make sure it is updated to the latest version.

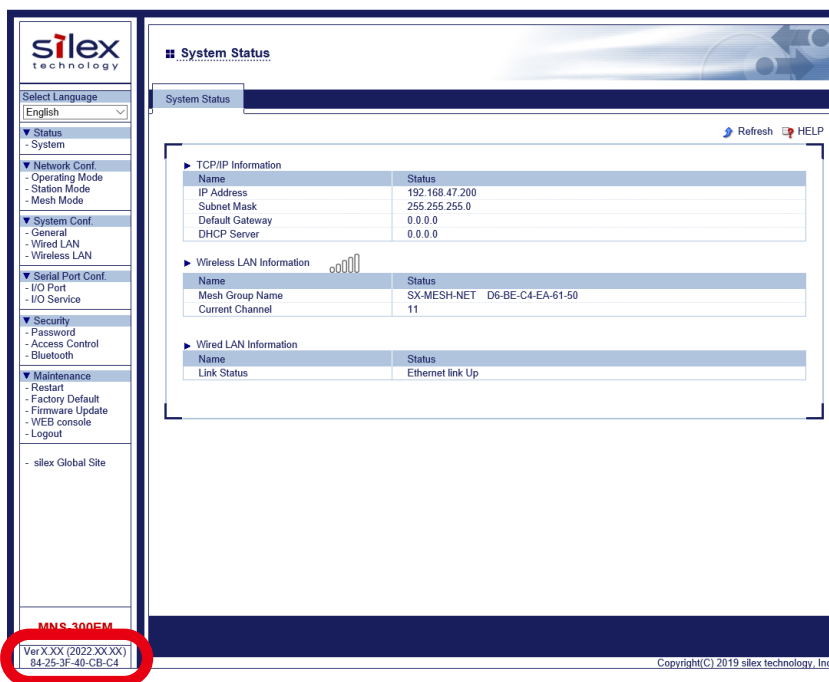

Now, the firmware update has been completed.

10-2-3. Firmware Update Using AMC Manager®

1. Start AMC Manager®, select a device to update the firmware from the device list, and click  on the toolbar.

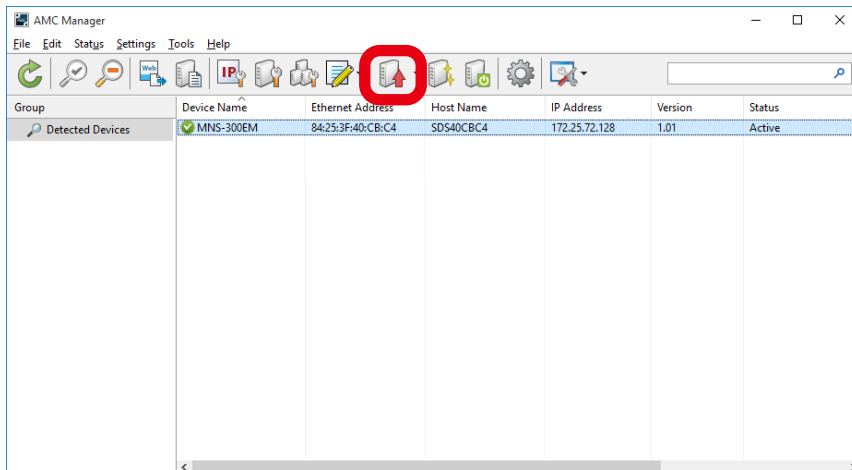

2. The firmware update window shows up. Click **Browse**.

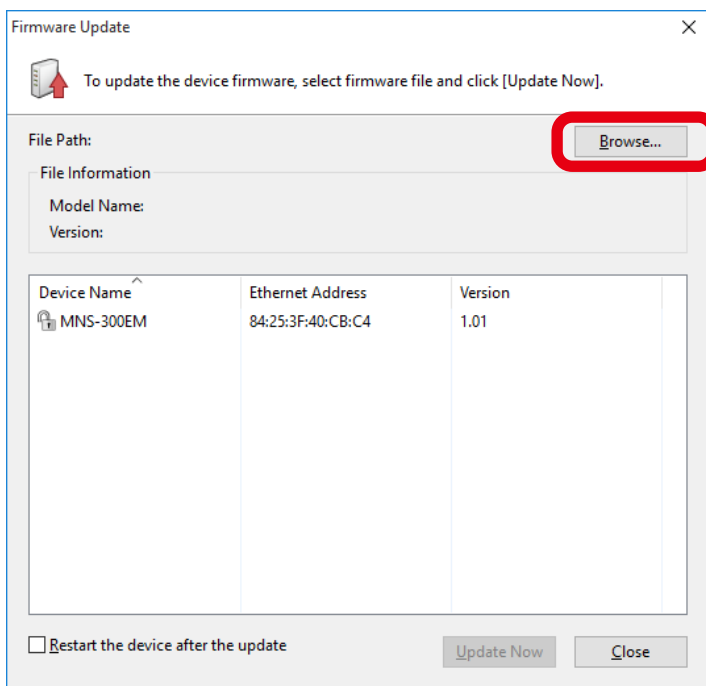

3. Choose **Firmware (*.zip)** from the pull-down menu (1), and choose the downloaded firmware (**MNS-300EM_xxx.zip**) (2).

* "**xxx**" of **MNS-300EM_xxx.zip** is the firmware version.

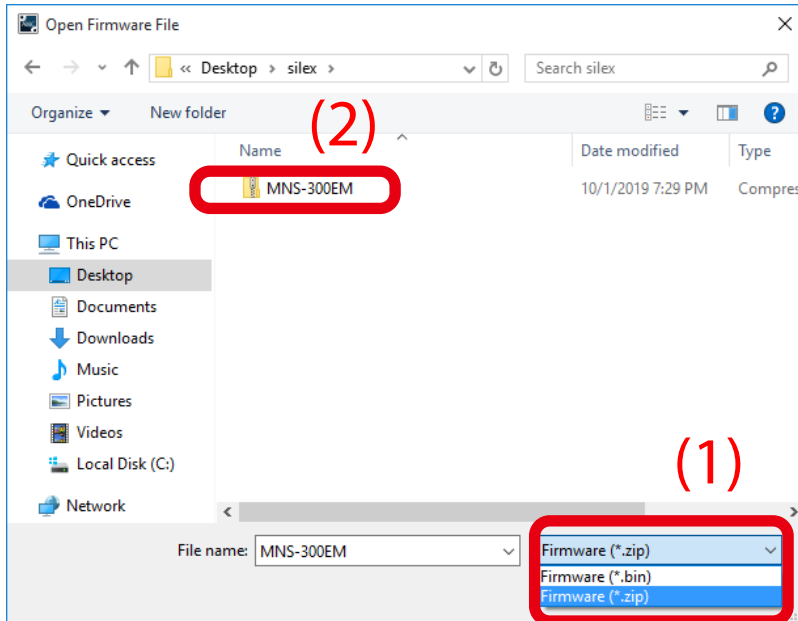

4. Check the file information of the selected firmware (1), tick **Restart the device after the update** (2), and click **Update Now** (3).

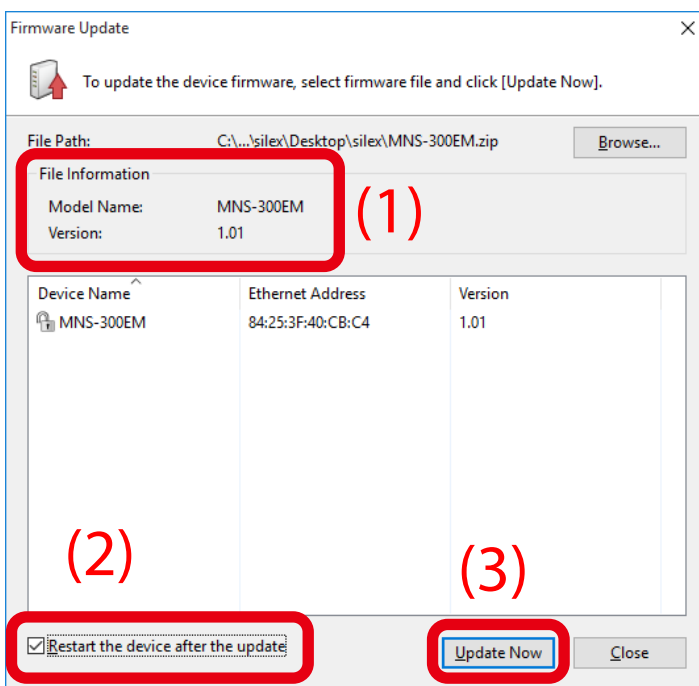

5. The password input window appears.
Enter the password of MNS-300EM (1), and click **OK** (2). When no password is set to MNS-300EM, this window does not show up.

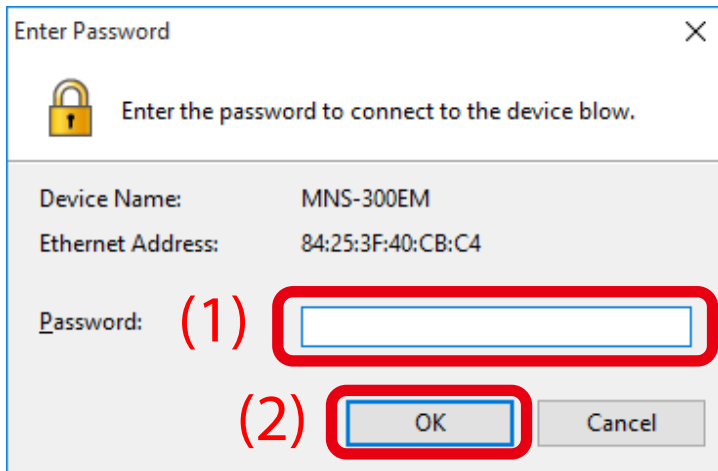

6. The firmware is updated. Click **Close** to close the window.

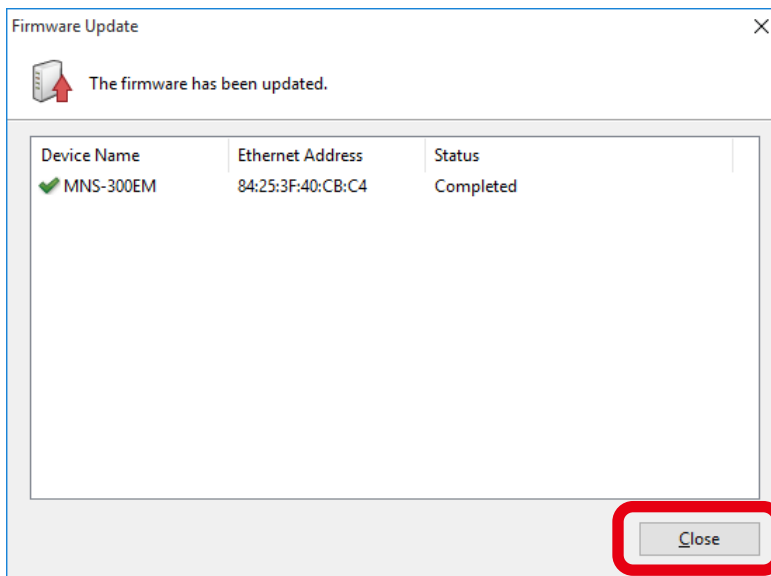

7. See the AMC Manager®'s device list to check that the firmware version has been updated.

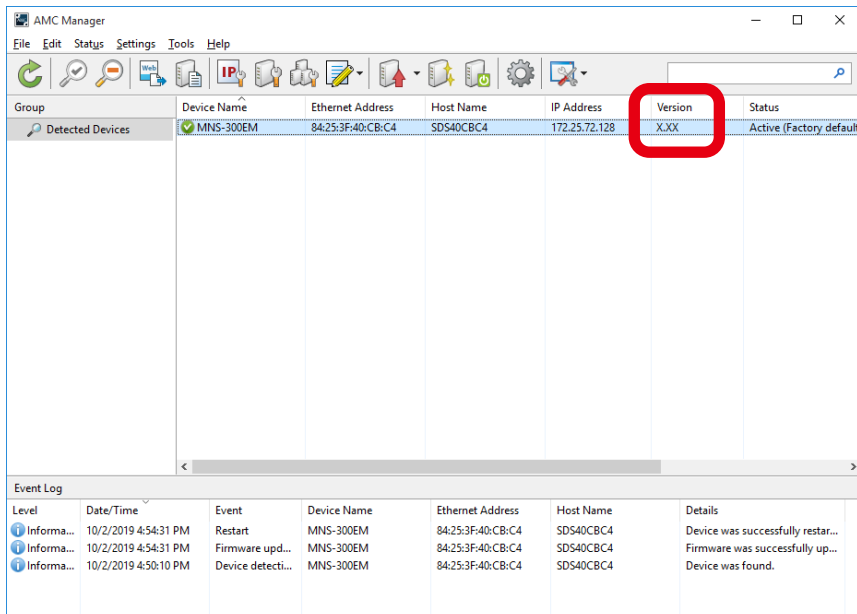

The screenshot shows the AMC Manager software interface. The main window displays a table of detected devices. The 'Version' column for the device 'MNS-300EM' is highlighted with a red circle and contains the text 'X.XX'. Below the device list is an 'Event Log' section with three entries:

Level	Date/Time	Event	Device Name	Ethernet Address	Host Name	Details
Informa...	10/2/2019 4:54:31 PM	Restart	MNS-300EM	84:25:3F:40:CB:C4	SDS40CBC4	Device was successfully restar...
Informa...	10/2/2019 4:54:31 PM	Firmware upd...	MNS-300EM	84:25:3F:40:CB:C4	SDS40CBC4	Firmware was successfully up...
Informa...	10/2/2019 4:50:10 PM	Device detecti...	MNS-300EM	84:25:3F:40:CB:C4	SDS40CBC4	Device was found.

Now, the firmware update has been completed.

10-2-4. Firmware Update Using tftp Command

1. Start the command prompt on the PC to update the firmware by tftp commands in Windows.



- To use tftp commands in an operating system other than Windows, see the documentation of that operating system for how to use it.

2. Execute the following command on the command prompt.
After the command is executed, the firmware update will begin.

tftp -i <ipaddress> put <filename>

ipaddress: Specify the IP address of MNS-300EM.

filename: Provide the file name of the firmware (full path).



Note

- For example, execute the following command to load the firmware (**MNS-300EM.bin**) of **/updates** folder to MNS-300EM of "192.168.5.70".

```
tftp -i 192.168.5.70 put /updates/MNS-300EM.bin
```

A. Configuration Items on Web Page

This chapter describes the configuration items on MNS-300EM's Web page.

Operating Mode Page

Operating Mode - Operating Mode Configuration	
Operating Mode	
Description	<p>Chooses the operating mode from Mesh, Station, and Auto.</p> <p>Mesh: Operates in MP mode, and connects to a Mesh network having the same Mesh group name as MNS-300EM's.</p> <p>Station: Operates in STA (wireless station) mode , and connects to an Access Point having the same SSID as MNS-300EM's</p> <p>Auto: Selects a network with the highest radio intensity based on the wireless client settings and the specified Mesh profile.</p>
Value/Range	Mesh/Station/Auto
Default value	Mesh

Operating Mode - Mesh Profile Configuration	
Selected Mesh Profile Configuration	
Description	<p>Chooses the Mesh profile to use.</p> <p>When the operating mode is Mesh, one Mesh profile can be selected.</p> <p>When the operating mode is Auto, multiple Mesh profiles can be selected out of five profiles.</p>
Value/Range	Select from Mesh profile 1-5.
Default value	<p>Mesh mode: 1 is selected.</p> <p>Auto mode: All of them (1 to 5) are selected.</p>

Station Mode Configuration Page

Station Mode Configuration - Wireless LAN Basic Configuration

SSID	
Description	Set the SSID of the wireless network. The SSID is an ID that distinguishes a wireless LAN network from others.
Value/Range	1 to 32 alphanumeric characters
Default value	serserv
Network Authentication	
Description	Select the network authentication mode that will be used to connect to the Access Point. To ensure a secure network, it is recommended to use WPA/WPA2. For IEEE 802.11n and IEEE 802.11ac, only AES can be used.
Value/Range	Open, WPA-Personal, WPA2-Personal, 802.1X, WPA-Enterprise, WPA2-Enterprise
Default value	Open
Note	<p>- Open (Open system): Allows any accesses without authentication. For encryption mode, WEP can be used.</p> <p>- WPA-Personal/WPA2-Personal: Uses PSK for network authentication. For encryption mode, TKIP/AUTO can be selected for WPA-Personal, and AES can be used for WPA2-Personal. The encryption key will be generated by communicating with the Access Point using a Pre-Shared key. WEP key setting is not used for this mode.</p> <p>- 802.1X: Uses EAP for the network authentication. For encryption mode, WEP can be used.</p> <p>- WPA-Enterprise/WPA2-Enterprise: Uses EAP for network authentication. For encryption mode, TKIP/AUTO can be selected for WPA-Enterprise, and AES can be used for WPA2-Enterprise. WEP key setting is not used for this mode.</p> <p>For IEEE 802.11n and IEEE 802.11ac, IEEE 802.1X authentication modes, WEP and TKIP encryption modes cannot be used.</p>
WEP	
Description	Enable/Disable the WEP encryption. If WEP encryption is used, wireless communication will be encrypted using the settings for WEP Key 1-4 and Key Index .
Value/Range	ON/OFF
Default value	OFF
Note	If encryption is not enabled, data is not encrypted and is sent as is. To ensure higher security, enabling encryption is recommended.

Station Mode Configuration - Wireless LAN Basic Configuration

Key Index

Description	Select the number of the WEP key to use for encryption (1-4). This setting must be the same as that of the wireless device to connect.
Value/Range	1 to 4
Default value	1

WEP Key 1-4

Description	Set the WEP key for WEP encryption. Up to 4 WEP keys can be set. This setting must be the same as that of the wireless device to connect (Access Point, etc.). To specify the WEP key, enter 26 digit hexadecimal value. The "hexadecimal" is a value consists of numbers (0-9) and English letters (A-F).
Value/Range	26 hexadecimal digits
Default value	00000000000000000000000000000000

Station Mode Configuration - WPA/WPA2 Configuration

Encryption Mode

Description	Select the encryption mode for WPA/WPA2 authentication. This setting must be the same as that of the wireless device to connect (Access Point, etc.).
Value/Range	AUTO/TKIP/AES
Default value	TKIP for WPA authentication, AES for WPA2 authentication
Note	Only AES can be used for IEEE802.11n/b/g, IEEE802.11n/a, and IEEE802.11ac.

Pre-Shared Key

Description	Set the Pre-Shared Key for WPA. The Pre-Shared Key must be 8-63 characters or 64 hexadecimal digits.
Value/Range	8-63 characters or 64 hexadecimal digits
Default value	Device Server

Station Mode Configuration - IEEE802.1X Configuration

EAP Authentication Mode

Description	Select the EAP authentication method from LEAP, EAP-TLS, EAP-TTLS, PEAP, and EAP-FAST when the network authentication is 802.1X or WPA/WPA2-Enterprise.
Value/Range	LEAP/EAP-TLS/EAP-TTLS/PEAP/EAP-FAST
Default value	TTLS
Note	<p>- EAP-TLS Provides mutual authentication by using the certificate between a client and RADIUS server.</p> <p>- EAP-TTLS, PEAP Authentication methods using EAP-TLS, which provide client authentication by using the user name and password.</p> <p>- EAP-FAST Provides the tunneled authentication process by using PAC (Protected Access Credential) issued by RADIUS server.</p> <p>- LEAP One of EAP protocols used for the PPP authentication, which provides authentication between a client and RADIUS server by using the user name and password.</p>

EAP User Name

Description	Specify a user name (1-63 alphanumeric characters) for IEEE802.1X authentication. This setting is used by the RADIUS server to identify the client.
Value/Range	1-63 alphanumeric characters
Default value	anonymous

EAP Password

Description	Specify a password (1-32 alphanumeric characters) for IEEE802.1X authentication. This setting is used by the RADIUS server to authenticate the client.
Value/Range	1-32 alphanumeric characters
Default value	anonymous

Inner Authentication

Description	Select the authentication protocol for EAP-TTLS.
Value/Range	PAP/MSCHAPv2
Default value	PAP

Station Mode Configuration - CA Certificate

Current Setting

Description	Show the information of current CA certificate. The CA certificate is needed for EAP-TLS, and is optional for EAP-TTLS and PEAP. To delete the certificate, tick Delete and click Submit in the bottom right corner of the Web page.
Default value	None

Certificate File

Description	Upload a certificate. When the certificate is already installed, it will be overwritten. The format has to be PEM-encoded X.509.
Value/Range	PEM-encoded X509 file
Default value	None
Note	When CA certificate is installed as an option of EAP-TLS/PEAP/EAP-TTLS, it will be used to verify the server certificate sent from RADIUS server.

Station Mode Configuration - Client Certificate

Current Setting

Description	Show the information of current client certificate. The client certificate is needed for EAP-TLS. To delete the certificate, tick Delete and click Submit in the bottom right corner of the Web page. Generate Certificate: Creates a self-signed client certificate. Download: Downloads a client certificate as a PEM-encoded X.509 file.
Default value	None

Certificate File

Description	Upload a certificate. When the certificate is already installed, it will be overwritten. The format has to be PEM-encoded X.509.
Value/Range	PEM-encoded X509 file
Default value	None



- Please create the client certificate and the CA certificate separately. MNS-300EM does not support the certificate composed of multiple certificate files.

Station Mode Configuration - Client Certificate Secret Key File

Current Setting

Description	<p>Show the information of current secret key.</p> <p>Since the secret key has to pair up with the client certificate, when a new client certificate is uploaded, the corresponding secret key has to be uploaded as well.</p> <p>When a self-signed certificate is generated, the corresponding secret key will automatically be generated.</p> <p>To delete the secret key, tick Delete and click Submit in the bottom right corner of the Web page.</p>
Default value	None

Certificate File

Description	<p>Upload a secret key.</p> <p>When the certificate is already installed, it will be overwritten. The format has to be PEM-encoded RSA or PKCS8.</p>
Value/Range	PEM-encoded RSA or PKCS8
Default value	None

Password

Description	Set a password that is configured when the secret key file is generated.
Value/Range	8-63 alphanumeric characters
Default value	None
Note	When a self-signed certificate is generated, this setting will automatically be configured.

Station Mode Configuration - Generate Self-Signed Certificate

Generate Self-Signed Certificate

Description	<p>Create a self-signed certificate. Self-signed certificates mean that certificates are not signed by a certificate authority. As they have a form of certificate but are not validated by a trusted third party, it is not appropriate to use them for an environment where high security is required.</p> <p>Self-signed certificates are mainly used for testing or temporal operation.</p> <p>Edit the information for the certificate if necessary, and click Submit. The certificate and secret key will be generated, and then, the station mode configuration page will be displayed again.</p>
Default value	<p>Certificate Common Name: MACXXXXXXXXXXXX (XXXXXXXXXXXX is the MNS-300EM's MAC address)</p> <p>Organization name: silex technology america</p> <p>Organizational unit: silex</p> <p>City name : Orange County</p> <p>State name: CA</p> <p>Country name: US</p> <p>Key Size: 1024</p>

Station Mode Configuration - Bridge Configuration

Bridge Mode

Description	Enable/Disable the wired/wireless LAN bridge function.
Value/Range	Enable/Disable
Default value	Disable
Note	If the wired/wireless LAN bridge function is used, communication of network devices connected to the wired LAN is forwarded to the Mesh network via MNS-300EM.

Bridge Static Client Address

Description	Enable/Disable the static MAC address mode for wired/wireless LAN bridge function. (ON/OFF). Change this setting when you do not want to use the MAC address of the device connected to the wired LAN, but want to use a different MAC address for the device and MNS-300EM.
Value/Range	ON/OFF
Default value	OFF
Note	When this is ON, the address registered to Clone MAC Address will be used as a clone MAC address. When this is OFF, the source address of the first packet received from the wired LAN will be used as the clone MAC address.

Clone MAC Address

Description	Set the MAC address to use for the device connected to MNS-300EM via a wired LAN.
Value/Range	17 characters
Default value	00-00-00-00-00-00
Note	When Bridge Static Client Address setting is OFF, the registered MAC address is ignored.

Station Mode Configuration - TCP/IP Configuration

DHCP

Description	<p>Choose the IP address configuration method for STA mode.</p> <ul style="list-style-type: none"> - AUTO: Attempts to get an address from DHCP server. If it fails, the static address of TCP/IP Configuration will be used. - DHCP: Attempts to get an address from DHCP server. Unlike AUTO, it keeps sending DHCP requests until it gets an address. - STATIC: Does not get an address from DHCP server but uses the static address of TCP/IP Configuration.
Value/Range	AUTO/DHCP/STATIC
Default value	AUTO

IP Address

Description	Specify the IP address.
Value/Range	0.0.0.0 to 255.255.255.255
Default value	169.254.111.111
Note	When DHCP client is enabled, an IP address automatically obtained from DHCP server will be applied.

Subnet Mask

Description	Specify the subnet mask.
Value/Range	0.0.0.0 to 255.255.255.255
Default value	255.255.0.0
Note	When DHCP client is enabled, a subnet mask automatically obtained from DHCP server will be applied. When 0.0.0.0 is given, a subnet mask corresponding to the IP address's class will be automatically applied.

Default Gateway

Description	Specify the default gateway. "0.0.0.0" (default value) disables this setting.
Value/Range	0.0.0.0 to 255.255.255.255
Default value	0.0.0.0
Note	When DHCP client is enabled, a default gateway automatically obtained from DHCP server will be applied.

Station Mode Configuration - TCP/IP Configuration

DNS Server (Primary)

Description	Specify the DNS primary server address.
Value/Range	0.0.0.0 to 255.255.255.255
Default value	0.0.0.0
Note	When DHCP client is enabled, DNS server address automatically obtained from DHCP server will be applied.

DNS Server (Secondary)

Description	Specify the DNS secondary server address.
Value/Range	0.0.0.0 to 255.255.255.255
Default value	0.0.0.0
Note	When DHCP client is enabled, DNS server address automatically obtained from DHCP server will be applied.

Smart Wireless Setup Page

Smart Wireless Setup - Smart Wireless Setup

PIN Code

Description	Shows the MNS-300EM's PIN code. Clicking Generate PIN creates a random PIN code.
Value/Range	xxxxxxx (8-digit decimal number)
Default value	Unique to each MNS-300EM unit

Mesh Mode Configuration Page

Mesh Profile 1 to 5 - Mesh Basic Configuration	
Wireless Mode	
Description	Specify the IEEE 802.11 wireless standard to be used for MNS-300EM.
Value/Range	802.11b/g, 802.11n/b/g, 802.11a, 802.11n/a, 802.11ac
Default value	802.11n/b/g
Note	802.11b/g: Uses IEEE 802.11b and IEEE 802.11g. 802.11n/b/g: Uses IEEE 802.11n, IEEE 802.11b, and IEEE 802.11g. 802.11a: Uses IEEE 802.11a. 802.11n/a: Uses IEEE 802.11n and IEEE 802.11a. 802.11ac: Uses IEEE 802.11ac.
Channel Bandwidth	
Description	Specify the frequency bandwidth. This setting can be changed when the wireless mode is 802.11n/a or 802.11ac .
Value/Range	20MHz/40MHz/80MHz
Default value	20MHz
Note	- 80MHz (Ultra high speed) Uses 4 frequency bands (20MHz x 4) for ultra high speed communications. This is even faster than 40MHz. - 40MHz (High speed) Uses 2 frequency bands (20MHz x 2) for high speed communication. - 20MHz (Standard) Uses the standard communication frequency bandwidth. Many bands are consumed for 40MHz (high speed) and 80MHz (ultra high speed) at once. If communication becomes unstable when 40MHz/80MHz bands are used, change it to 20MHz .
Channel	
Description	Set the wireless channel. A channel is the divided frequency bandwidth. In a wireless network, bandwidth is divided up so that more devices can communicate at a time. The selectable channels will differ depending on the wireless mode.
Value/Range	When the wireless mode is 802.11b/g or 802.11n/b/g : (US) 1-11 (EU/UK) 1-13 When the wireless mode is 802.11a , 802.11n/a or 802.11ac : (US) 36/40/44/48/149/153/157/161/165 (EU/UK) 36/40/44/48
Default value	11

Mesh Profile 1 to 5 - Mesh Basic Configuration

Mesh Group Name

Description	Set a group name of the Mesh network to create or join (up to 32 characters). The Mesh network is identified by the Mesh group name. To join the Mesh network, MNS-300EM needs to have the same Mesh group name as that Mesh network.
Value/Range	1-32 alphanumeric characters (The marks (" ' \) cannot be used.)
Default value	SX-MESH-NET

Mesh Encryption Key

Description	Specify the encryption key for Mesh network communication.
Value/Range	1-32 alphanumeric characters (The marks (" ' \) cannot be used.)
Default value	silex technology, Inc.
Note	The Mesh encryption key must be the same for all Mesh devices to join the Mesh network.

Mesh Profile 1 to 5 - Mesh Extended Configuration

Max Hop Count

Description	Specify the maximum number of Mesh devices to create Mesh route. When six hops or more are required for your environment, set the value to No Limit . The communication speed decreases as the number of hops increases.
Value/Range	1, 2, 3, 4, 5, No Limit
Default value	No Limit
Note	The number of hops represents how many MNS-300EM units are used for communication relay. This number should exclude the number of source unit (1 hop = 2 devices, 5 hops = 6 devices).

Route Refresh Function

Description	Enable/Disable the regular optimization for the Mesh route.
Value/Range	ENABLE / DISABLE
Default value	ENABLE

Route Refresh Method

Description	Choose the Mesh route refresh method from the following: - Light Refresh Mode Rebuilds the routes to MNS-300EM. - Full Refresh Mode Rebuilds the routes to/from MNS-300EM.
Value/Range	Light refresh mode/ Full refresh mode
Default value	Light refresh mode

Mesh Profile 1 to 5 - Mesh Extended Configuration	
Route Refresh Interval	
Description	Set a refresh interval for the Mesh route (sec).
Value/Range	1-86400
Default value	3600
Route Switching Mode	
Description	Select a method to execute the route refresh. - Responsive Type: Always performs a route refresh. - Stable Type: Performs a route refresh only when communication quality is good.
Value/Range	Responsive Type/Stable Type
Default value	Stable Type
Note	If this setting is set to Stable Type , the communication delay can be improved as the frequency of route change is reduced. This setting must be the same for all Mesh devices in the Mesh network. If the setting is different for some Mesh devices, the communication route may not be constructed correctly. When the firmware version is 2.00 or lower, MNS-300EM operates in Responsive Type .
Transmission Control Function	
Description	Enable/Disable the upper limit on amount of data that can be sent per second. When this setting is enabled, amount of data exceeding the upper limit will be discarded.
Value/Range	ENABLE/DISABLE
Default value	ENABLE
Note	By enabling the upper limit on amount of data transmission, the bandwidth occupancy of the entire Mesh network can be reduced. The upper limit of data amount is calculated based on the communication quality. When the route refresh interval is long, or when the route quality frequently changes in the Mesh network, this may not work effectively. This setting is valid when Stable Type is selected for the route switching mode.
Mesh Power Save Function	
Description	Enable/Disable the power saving function for Mesh network communication. When it is enabled, the MNS-300EM is hardly selected as a part of Mesh route.
Value/Range	ENABLE/DISABLE
Default value	DISABLE

Mesh Profile 1 to 5 - TCP/IP Configuration

DHCP

Description	<p>Choose the IP address configuration method for MP mode.</p> <ul style="list-style-type: none"> - DHCP Attempts to get an address from DHCP server. It keeps sending DHCP requests until it gets an address. - STATIC Does not get an address from DHCP server but uses the static address of TCP/IP Configuration.
Value/Range	DHCP/STATIC
Default value	DHCP

IP Address

Description	Specify the IP address.
Value/Range	0.0.0.0 to 255.255.255.255
Default value	0.0.0.0
Note	When DHCP client is enabled, an IP address automatically obtained from DHCP server will be applied.

Subnet Mask

Description	Specify the subnet mask.
Value/Range	0.0.0.0 to 255.255.255.255
Default value	0.0.0.0
Note	When DHCP client is enabled, a subnet mask automatically obtained from DHCP server will be applied. When 0.0.0.0 is given, a subnet mask corresponding to the IP address's class will be automatically applied.

Default Gateway

Description	Specify the default gateway. "0.0.0.0" (default value) disables this setting.
Value/Range	0.0.0.0 to 255.255.255.255
Default value	0.0.0.0
Note	When DHCP client is enabled, a default gateway automatically obtained from DHCP server will be applied.

DNS Server (Primary)

Description	Specify the DNS primary server address.
Value/Range	0.0.0.0 to 255.255.255.255
Default value	0.0.0.0
Note	When DHCP client is enabled, DNS server address automatically obtained from DHCP server will be applied.

Mesh Profile 1 to 5 - TCP/IP Configuration

DNS Server (Secondary)

Description	Specify the DNS secondary server address.
Value/Range	0.0.0.0 to 255.255.255.255
Default value	0.0.0.0
Note	When DHCP client is enabled, DNS server address automatically obtained from DHCP server will be applied.

General Configuration Page

General Configuration - General Configuration

System Name

Description	Enter a unique name for the MNS-300EM.
Value/Range	ASCII printable string (up to 15 characters)
Default value	SDSxxxxxx (xxxxxx is the last 6 digits of the MAC address.)

System Description

Description	Enter a description for MNS-300EM that may provide helpful information about the product.
Value/Range	ASCII printable string (up to 64 characters)
Default value	Silex MNS-300EM
Note	When nothing is entered, the default value will be applied.

System Contact

Description	Enter the name of the person to contact for information about the product.
Value/Range	ASCII printable string (up to 63 characters)
Default value	None
Note	Factory reset does not initialize this setting.

System Location

Description	Enter the location of the product.
Value/Range	ASCII printable string (up to 63 characters)
Default value	None

SNMP Get Community Name

Description	Specify the community name used to obtain SNMP information from MNS-300EM.
Value/Range	ASCII printable string (up to 16 characters)
Default value	public
Note	The value is not displayed on the Web page.

General Configuration - General Configuration

SNMP Set Community Name

Description	Specify the community name used to configure SNMP information on MNS-300EM.
Value/Range	ASCII printable string (up to 16 characters)
Default value	public
Note	The value is not displayed on the Web page.

Wired LAN Configuration Page

Wired LAN Configuration - Wired LAN Basic Configuration

LAN Interface

Description	Select the physical network type. In most cases, AUTO is used. If the LINK lamp on your HUB does not light up when MNS-300EM is turned on, configure this setting to match that of the HUB.
Value/Range	AUTO/10HALF/10FULL/100HALF/100FULL
Default value	AUTO

Wireless LAN Configuration Page

Wireless LAN Configuration - Communication Recovery Configuration

Communication Recovery Function

Description	This is the function to restart the wireless LAN to recover from the communication idle state that may occur as a result of multipath or radio wave interference. If this function is enabled, the wireless LAN will be restarted after a certain period of time configured at Communication Idle Period . It takes about 15 sec to restart the communication.
Value/Range	DISABLE/ENABLE
Default value	DISABLE

Wireless LAN Configuration - Communication Recovery Configuration

Communication Idle Period

Description	Set the amount of time until the communication idle state that triggers the restart of wireless LAN. The value must be 500-3600000 msec. If this setting is not appropriate for the system, the wireless LAN may be restarted unintentionally and communication may become unstable. Example) When the system communicates at 1-sec interval regularly and you want to make a system error if the communication is lost for 30 sec: Communication Recovery Function: ENABLE Communication Idle Period: 15000 (msec)
Value/Range	500-3600000 msec
Default value	500
Note	This recovery function can be used for an environment where the communication performs regularly. It cannot be used when only irregular communication performs.

I/O Port Configuration S1 Page

I/O Port Configuration S1 - I/O Port Configuration

Baud Rate

Description	Select the speed at which the serial port should send and receive data.
Value/Range	300, 600, 1200, 2400, 4800, 9600, 19200, 38400, 57600, 115200, 230400, 460800, 921600, 3000000
Default value	115200

Bits per Character

Description	Select the number of bits per character.
Value/Range	8/7
Default value	8

Stop bits

Description	Select the number of stop bits after each character.
Value/Range	1/2
Default value	1

Parity

Description	Select the parity scheme for each character.
Value/Range	None/Odd/Even
Default value	None

I/O Port Configuration S1 - I/O Port Configuration

Flow control

Description	Select the flow control method.
Value/Range	None, XON/XOFF, RTS/CTS
Default value	None

I/O Port Configuration S1 - Ecable Mode Configuration

Ecable Mode

Description	Enable/Disable the Ecable mode.
Value/Range	Enabled/Disabled
Default value	Disabled

Ecable I/O Mode

Description	Select a network protocol for remote host I/O to use when Ecable mode is enabled.
Value/Range	TCP/UDP
Default value	TCP

Destination IP Address

Description	Enter the IP address of the device to make a connection with when Ecable mode is enabled. It is possible to specify this using a host name when TCP mode is on.
Value/Range	0.0.0.0 to 255.255.255.255
Default value	0.0.0.0

Destination Port

Description	Enter the TCP port number of the device to make a connection with when Ecable mode is enabled.
Value/Range	0 or an integer between 1024 and 65534
Default value	0

Local Port

Description	Enter the port of local server that a remote client sends data to when UDP mode is on and Ecable mode is enabled.
Value/Range	0 or an integer between 1024 and 65534
Default value	0

Connection attempt time

Description	Specify the Ecable connection attempt interval.
Value/Range	0-9999
Default value	30

I/O Port Configuration S1 - Ecable Mode Configuration

Connection attempt time unit

Description	Specify the unit of Ecable connection attempt interval.
Value/Range	sec/msec
Default value	sec

Console Mode String

Description	If this string is defined, input from serial port will be scanned. When a string is received that matches this string, the serial port will switch to console mode.
Value/Range	31 or less characters
Default value	+++

I/O Port Configuration S2 Page

I/O Port Configuration S2 - I/O Port Configuration

Baud Rate

Description	Select the speed at which the serial port should send and receive data.
Value/Range	300, 600, 1200, 2400, 4800, 9600, 19200, 38400, 57600, 115200, 230400, 460800, 921600, 3000000
Default value	115200

Bits per character

Description	Select the number of bits per character.
Value/Range	8/7
Default value	8

Stop bits

Description	Select the number of stop bits after each character.
Value/Range	1/2
Default value	1

Parity

Description	Select the parity scheme for each character.
Value/Range	None/Odd/Even
Default value	None

Flow control

Description	Select the flow control method.
Value/Range	None, XON/XOFF, RTS/CTS
Default value	None

I/O Service Configuration A/B Page

I/O Service Configuration A/B - Port Service Configuration A/B

Port	
Description	Specify the physical port associated with the service.
Value/Range	S1
Default value	S1
Service Name	
Description	Specify the service name. Usually, this field does not need to be changed.
Value/Range	1-32 alphanumeric characters, - (hyphen), _ (underscore)
Default value	SDSxxxxxx_S1_A for port service setting A SDSxxxxxx_S1_B for port service setting B (xxxxxx is a last 6 digits of Ethernet Address.)
Raw TCP Port	
Description	Specify the TCP port to use when this service is connected. When 0 is specified, the service is not used.
Value/Range	0 or an integer between 1024 and 65534
Default value	9100 for port service setting A 3001 for port service setting B
Bi-Directional Support	
Description	When ON is selected, the service sends data back from the connected device to network. Usually, this setting does not need to be changed.
Value/Range	OFF/ON
Default value	ON
Queued (TCP)	
Description	When ON is selected and raw TCP port is specified, MNS-300EM adds the job to queue after it is sent to that port. When OFF is selected, the received job is discarded when MNS-300EM is handling other jobs.
Value/Range	OFF/ON
Default value	OFF

Password Configuration Page

Password Configuration	
New Password	
Description	Specify a password for administration.
Value/Range	1-8 alphanumeric characters
Default value	None
Note	The password is used to login to the Web page or the console, and to change the settings by AMC Manager®.

Access Control Configuration Page

Access Control Configuration - Protocol Filter Configuration	
HTTP (80)	
Description	Enable the use of HTTP. When it is OFF, the Web page cannot be accessed.
Value/Range	ON (Enabled)/OFF (Disabled)
Default value	ON
TFTP (69)	
Description	Enable the use of TFTP.
Value/Range	ON (Enabled)/OFF (Disabled)
Default value	OFF
SNMP (161)	
Description	Enable the use of SNMP.
Value/Range	ON (Enabled)/OFF (Disabled)
Default value	ON
NTP (123)	
Description	Enable the use of NTP.
Value/Range	ON (Enabled)/OFF (Disabled)
Default value	ON

Access Control Configuration - Protocol Filter Configuration

TCP Port (9100,3001,9101,3002)

Description	Enable the use of TCP Port.
Value/Range	ON (Enabled)/OFF (Disabled)
Default value	ON

Access Control Configuration - IP Filter Configuration

Starting Address / Ending Address

Description	Specify a range of IP address to allow an access to MNS-300EM. If the starting/ending addresses are registered, the devices of that address range will be allowed to access MNS-300EM.
Value/Range	0.0.0.0 to 255.255.255.255
Default value	0.0.0.0

Bluetooth Configuration Page

Bluetooth Configuration - Bluetooth Configuration

Bluetooth Configuration Function

Description	Enable/Disable the configuration via Bluetooth.
Value/Range	ENABLE/DISABLE
Default value	DISABLE

Bluetooth Passkey

Description	Specify the pass key to use when MNS-300EM is connected for configuration via Bluetooth .
Value/Range	0 - 999999
Default value	000000

B. Wireless Configuration Using AMC Manager Mobile

This chapter describes the MNS-300EM's configuration tool "AMC Manager Mobile".

B-1. AMC Manager Mobile

B-1-1. AMC Manager Mobile

AMC Manager Mobile is one of MNS-300EM's configuration tools that can refer/change the configuration from mobile devices (e.g. tablets, smartphones) via Bluetooth.

For example, as shown in the image below, when MNS-300EM-embedded device is isolated from the Mesh network due to a network trouble, the detection of the device is impossible even if AMC Manager® is used. For such a case, AMC Manager Mobile can be used to change the configuration of the isolated device using Bluetooth communication.

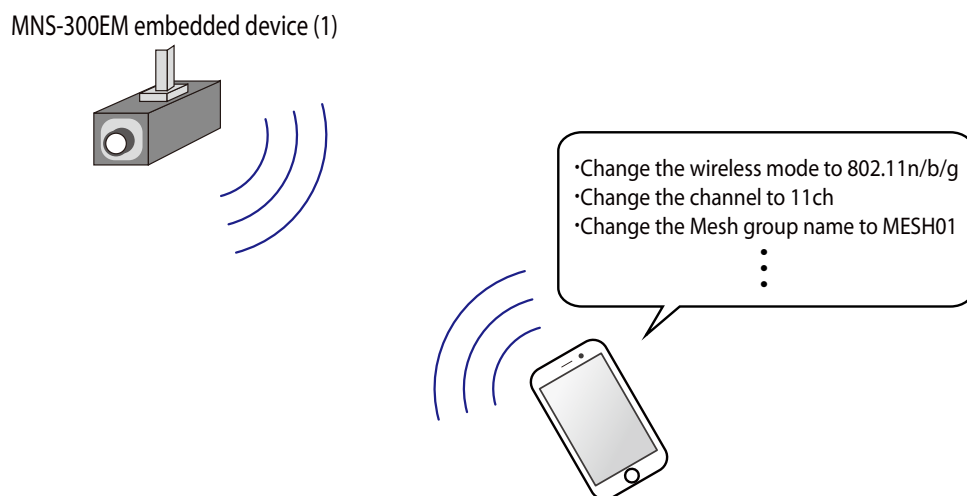
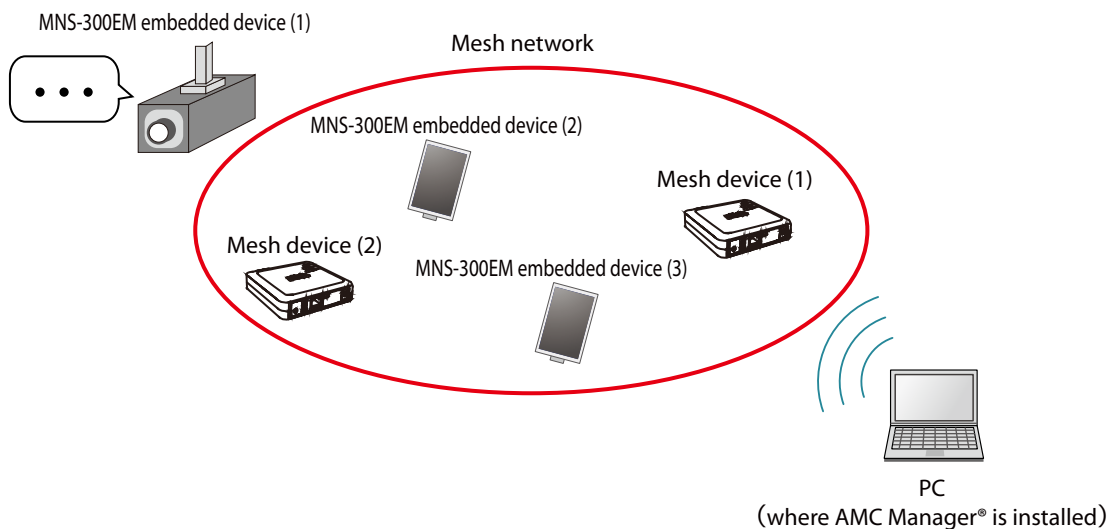

Also, AMC Manager Mobile can copy the Mesh network setting of other Mesh devices to use it to correct the configuration of the isolated device.

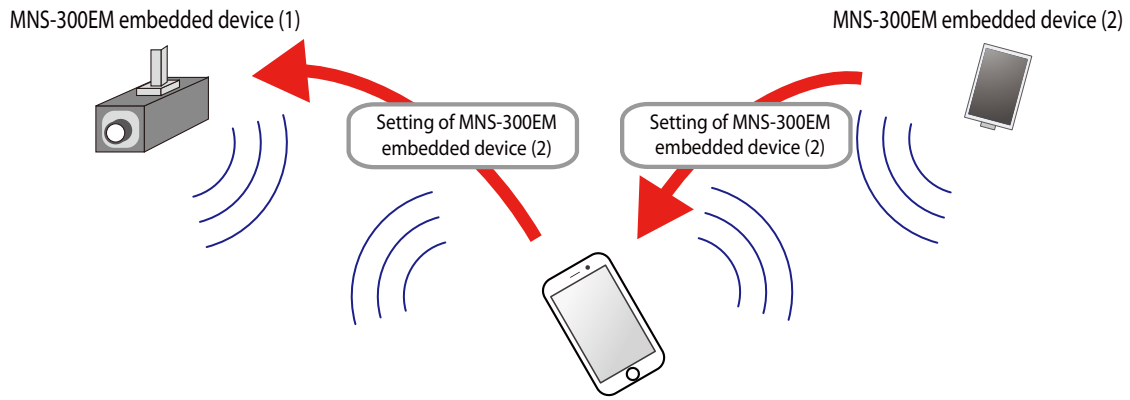

B-1-2. How to Download AMC Manager Mobile

AMC Manager Mobile Operating Environment

The following shows the operating environment for AMC Manager Mobile.

Item	Description
OS	iOS 10 - iOS 12.x
Language	English, Japanese
Device requirements	Bluetooth Low Energy needs to be supported.

How to Download AMC Manager Mobile

AMC Manager Mobile can be downloaded from App Store for free.



B-2. How to Enable Bluetooth Configuration Function

To use AMC Manager Mobile, the Bluetooth configuration function needs to be enabled on MNS-300EM beforehand. The following shows how to enable the Bluetooth configuration function.

1. Access the MNS-300EM's Web page using the Web browser.



• For details, see [How to Access the MNS-300EM's Web Page](#).

Note

2. Click **Bluetooth** from the page menu.

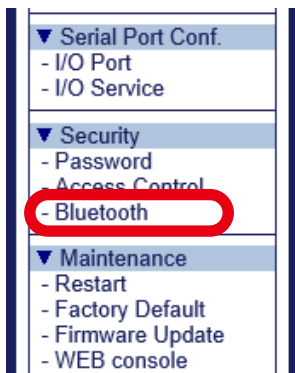

3. Select **ENABLE** for **Bluetooth Configuration Function**, and enter the connection passkey to **Bluetooth Passkey** (1). Click **Submit** then (2).

Bluetooth Configuration

Bluetooth Configuration

HELP

Name	Value
Bluetooth Configuration Function	DISABLE
Bluetooth Passkey	000000

Submit

4. Restart MNS-300EM to take effect of the settings. Click **Restart** from the page menu, and click **Yes** in the displayed page.

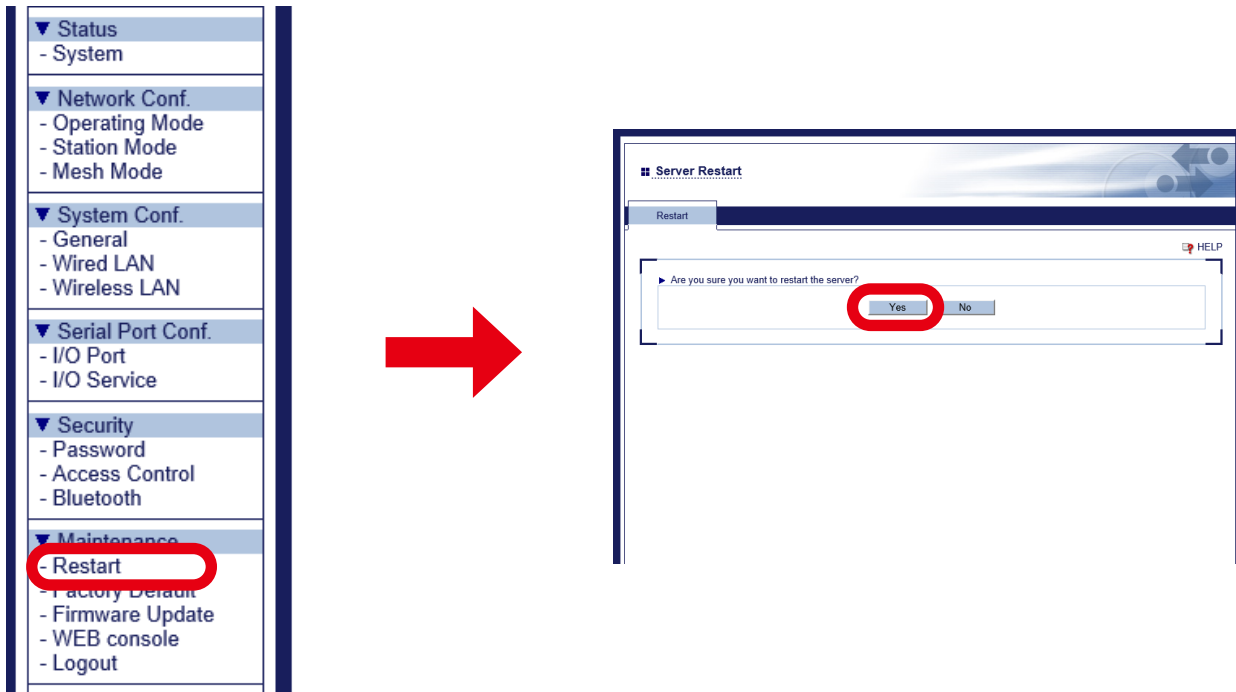

Now, the settings are completed.

B-3. How to Copy Settings Using AMC Manager Mobile

The following shows how to copy the configuration to other MNS-300EM units.

1. Start AMC Manager Mobile.

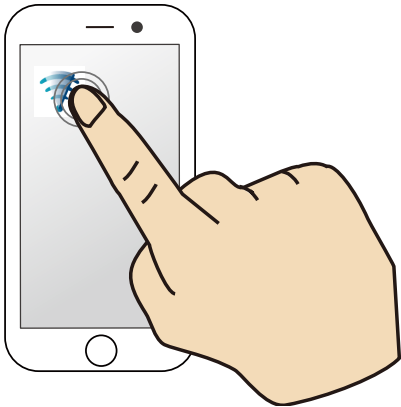

2. The MNS-300EM units are found and shown on a list.

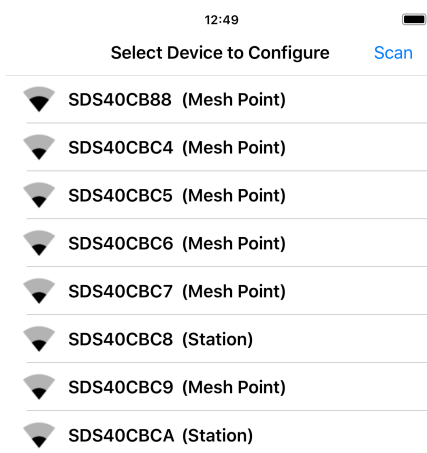

Note

- In the list, MNS-300EM's system name and operating mode are shown. When MNS-300EM is operating in Auto mode and not establishing wireless communication, the operating mode is shown as **Undefined**.

3. Select the target one and tap **Copy the setting of other devices** from the displayed menu.

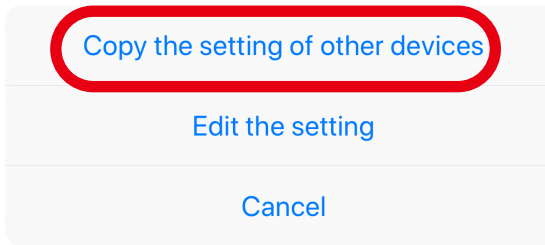

4. The window shows the list of copy sources. Tap the one to copy the setting from.

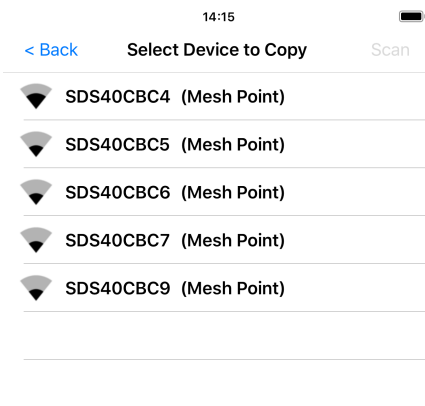

• Only MNS-300EM operating in MP mode can be selected as the copy source.

The following settings can be copied.

Category	Item	Description	
Wireless setting	Operating mode	Operating mode	
Mesh settings	Number of profile in use	Number of Mesh profile used for Mesh mode	
	Profile settings	Auto mode target	Defines if Mesh profile of Number of profile in use can be used in Auto mode.
		Wireless mode	Wireless mode
		Channel	Communication channel
		Channel bandwidth	Bandwidth
		Mesh group name	Group name of Mesh network
		Mesh encryption key	Encryption key to use for Mesh network communication

5. Two confirmation dialogues will appear.

Tap **OK** in the first dialogue, and tap **Yes** in the next dialogue. The configuration of the device you have selected at step 4 will be copied to the device you have selected at the step 3.



Note

- When the following window appears, enter the Bluetooth pass key (1), and tap **Pair** (2).

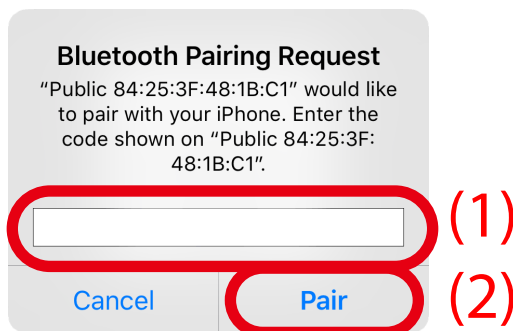

6. The following dialogue appears when the copy is completed. Tap **OK** to restart MNS-300EM.

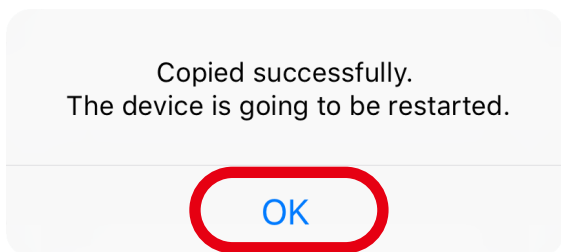

B-4. Configuration Using AMC Manager Mobile

The following shows how to change the MNS-300EM setting from mobile devices.

1. Start AMC Manager Mobile.

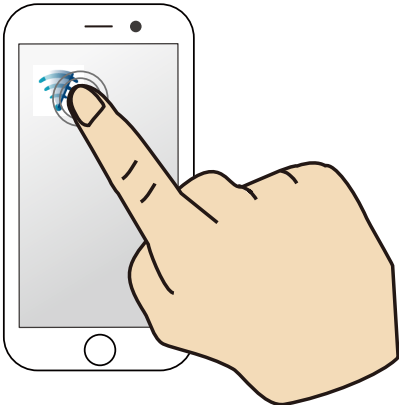

2. The MNS-300EM units are found and shown on a list.

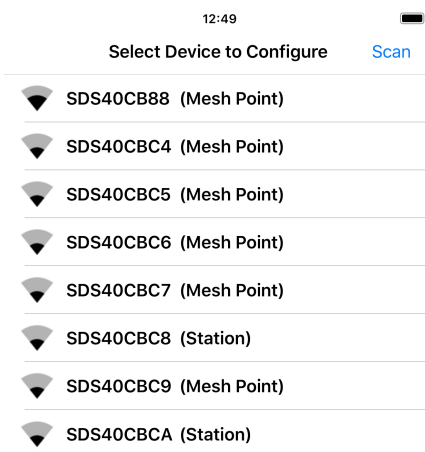

Note

- In the list, MNS-300EM's system name and operating mode are shown. When MNS-300EM is operating in Auto mode and not establishing wireless communication, the operating mode is shown as **Undefined**.

3. Select the target one and tap **Edit the setting** from the displayed menu.

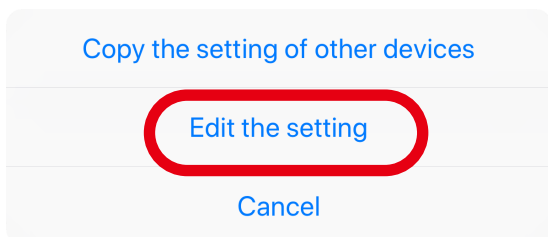

Note

- When the following window appears, enter the Bluetooth pass key (1), and tap **Pair** (2).

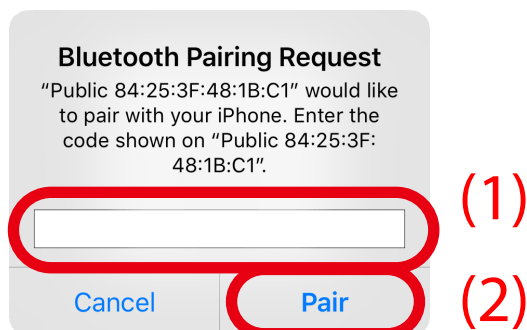

4. The device setting page appears. Tap the item to change. When finished editing, tap **Execute**.

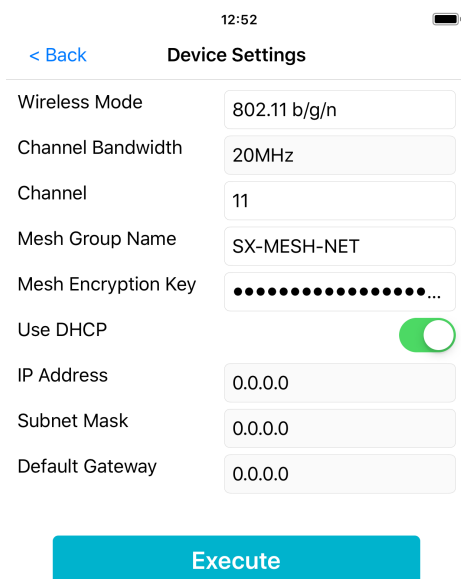

Note

- The displayed setting is the setting of **Mesh Profile 1**.
- When **Execute** is tapped, the setting of **Mesh Profile 1** will be changed. Also, the operating mode will be changed to **Mesh** and the profile number will be changed to **1**.

The following items can be configured.

Category	Item	Description
Mesh settings	Wireless Mode	Changes the wireless mode. Select the mode from 802.11b/g, 802.11b/g/n, 802.11a, 802.11a/n, and 802.11ac.
	Channel Bandwidth	Changes the channel bandwidth. Available bandwidths vary depending on the wireless mode. 802.11a/n: 20MHz / 40MHz 802.11ac: 20MHz / 40MHz / 80MHz Others: Fixed to 20MHz
	Channel	Specifies the communication channel. Available channels vary depending on the wireless mode. 802.11a/n & 802.11ac: 5GHz channels Others: 2.4GHz channels
	Mesh Group Name	Changes the Mesh group name. (1-32 alphanumeric characters (" ' ¥ cannot be used.))
	Mesh Encryption Key	Changes the encryption key for the Mesh network communication. (1-32 alphanumeric characters (" ' ¥ cannot be used.))
Network settings	Use DHCP	Enables/disables the DHCP client. Enable: Gets an IP address from DHCP server. Disable: Operates with the following IP Address , Subnet Mask , and Default Gateway .
	IP Address	Changes the IP address. When DHCP client is enabled, this setting will not be applied.
	Subnet Mask	Changes the subnet mask. When DHCP client is enabled, this setting will not be applied.
	Default Gateway	Changes the default gateway. When DHCP client is enabled, this setting will not be applied.

- When the following dialog appears, the configuration has been completed. Tap **OK** to restart MNS-300EM.

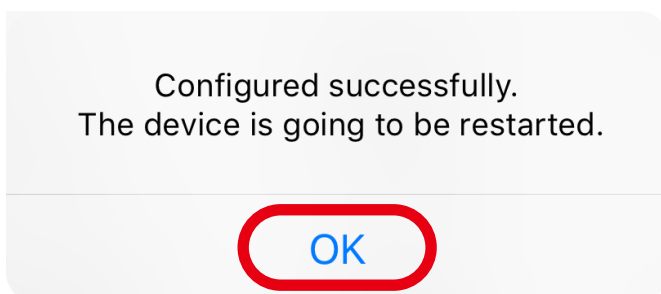

(Blank Page)