

DS-700 Setup Guide

English

silex
technology



WA106280XA

Thank you for purchasing the USB Device Server "DS-700". This Setup Guide provides information on how to configure and use the DS-700 in your network.

Package Contents

- DS-700
- AC adaptor
- Setup Guide (this document)
- GPL Inquiry Card

Name of Parts

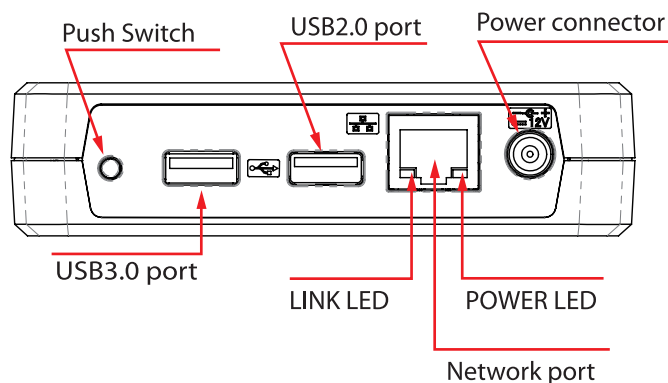

Setup Flow

Step 1. Power on

Connect the DS-700 to your network.

Step 2. Configuration

Download the necessary utility and configure the DS-700 using it.

Step 3. Using the USB Devices over Network

Start using the USB devices by connecting it using SX Virtual Link.

Step 1. Power on

How to power on the DS-700 is explained:

- 1** The following items are required.

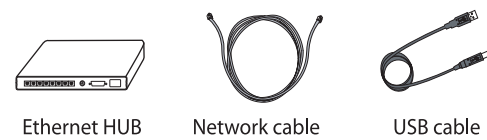

* If the DS-700 has been used in another network, reset it to factory default first (see below for details).

- 2** Connect the DS-700 to the Ethernet HUB using a network cable (1).

- 3** Connect the DS-700 to the USB device using a USB cable (2).

* There are USB devices not supported due to the driver specification. Please check the latest compatibility information on our website.

* For each USB port, only 1 device can run on bus power.

* The USB3.0 port of DS-700 does not support connection with a USB HUB, USB HUB embedded device and USB video converter.

- 4** Connect the AC adaptor to the DS-700 (3) and the AC plug to the power outlet (4). Check that POWER LED and LINK LED turn on (5).

* Be sure to use the AC adaptor that came with the DS-700.

- 5** If the USB device requires external power, use the power supply cable (6).

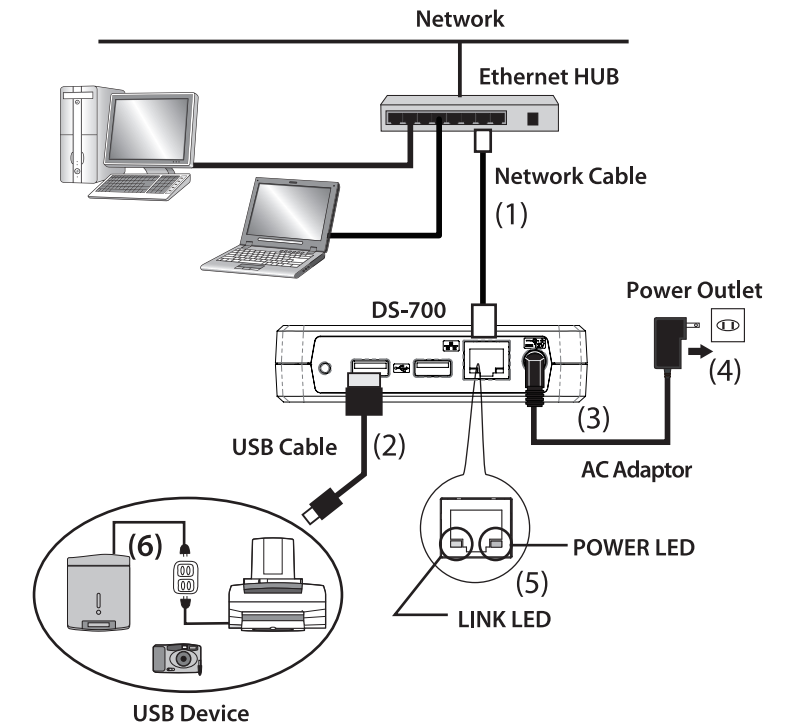

Factory Default Configuration

- 1** Remove the AC plug from the power outlet (1).

- 2** Press and hold the push switch while inserting the AC plug back into the power outlet (2). Continue holding.

When the LINK LED(orange)(3) turns on, the factory default configuration begins.

- 3** Release the push switch when the LINK LED(orange) turns off. The factory default configuration is completed.

* Do not release the push switch until the LINK LED(orange) turns off.

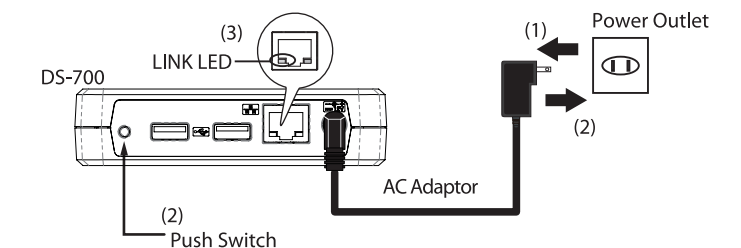

Step 2. Configuration

2-1. Downloading the Necessary Items

This section explains how to download the necessary utilities and user's manual from our website.

- 1** Access the URL below from the computer you are using to configure the DS-700.

URL: <https://www.silextechnology.com/>

- 2** Go to the **Support** page and select the product model.

Product Model DS-700

- 3** Download the utilities and documents below to your computer.

Utility	Device Server Setup
	SX Virtual Link
User's Manual	DS-700 User's Manual
	Device Server Configuration guide

2-2. Configuration

How to configure the DS-700 is explained:

By default, the DS-700 is configured to automatically obtain an IP address from the DHCP server. If the DHCP server is installed on your network, the configuration will not be necessary. In such a case, go on to install the SX Virtual Link (see the back).

When you want to configure the IP address manually or you are not sure if there is the DHCP server on your network, move on to **1**.

* Before moving on to **1**, please temporarily disable the firewall function of the computer you use for configuration. Some of the methods to disable the firewall are provided in the FAQ on our homepage.

- Commercial security software's firewall function

- 1** Extract the Device Server Setup file that you have downloaded at **2-1. Downloading the Necessary Items**.

- 2** Configure the DS-700 using **Device Server Setup** utility according to instructions on **Device Server Configuration** guide (PDF file).

Step 3. Using the USB Devices over Network

The SX Virtual Link is the software program to make a communication between your computer and the USB devices connected to the device server.
To use the USB devices over the network, you have to connect to or disconnect from it using the SX Virtual Link.

3-1. Installing the SX Virtual Link

If the SX Virtual Link is not installed to your computer, install it by following the instructions in this section.

1 Extract the SX Virtual Link file that you have downloaded at **2-1. Downloading the Necessary Items**.

2 See the contained PDF manual (SX Virtual Link Installation) to install the SX Virtual Link.

The SX Virtual Link installer will restart your computer after it is installed. Make sure that you finished all software programs on your computer before starting the installation.

3-2. Basic Use of the SX Virtual Link

Starting the SX Virtual Link

Click the application icon (🔗) in the task tray or go to the **Start** menu and click **silex Tools - SX Virtual Link** from the app list.

Connecting the USB devices

* When using the USB device for the first time, you may need to install the device driver for that USB device.

To install the driver, refer to the operating manual that came with the USB device, or follow the instructions on the screen displayed after clicking the **Connect** button in the SX Virtual Link.

1 Select a USB device and click the **Connect** button (🔗). The USB device can be connected when the status icon [🔗] is displayed.

- * The USB device can also be connected by selecting and double-clicking it on the SX Virtual Link.
- * If a device server is not displayed on a list, please click the **Refresh** button (🔄).
- * Do not unplug the USB cable or network cable, or click the **Disconnect** button (🔌) on the SX Virtual Link while the USB device is in use.

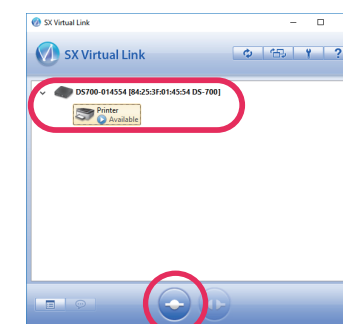

2 The Plug and Play function automatically creates an appropriate environment to use the selected device.

The USB device will be ready to use once the status icon has changed to [🟢]. See the operating manual that came with your USB device for how to use it.

* Only one device can be connected at a time. When the USB device is in use by another computer, the status icon [🔌] is displayed, which means that the USB device is not available now.

Disconnecting the USB devices

When you have finished using the USB device, disconnect the device by selecting it and clicking the **Disconnect** button (🔌).

* The USB device can also be disconnected by selecting and double-clicking it on the SX Virtual Link.

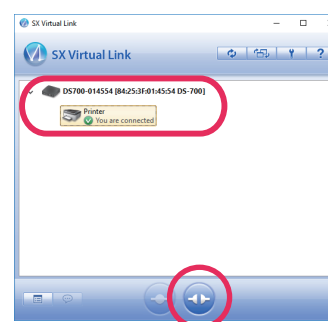

Accessing Online Help

Click the Help button (🔍) and select **Help** from the menu displayed.

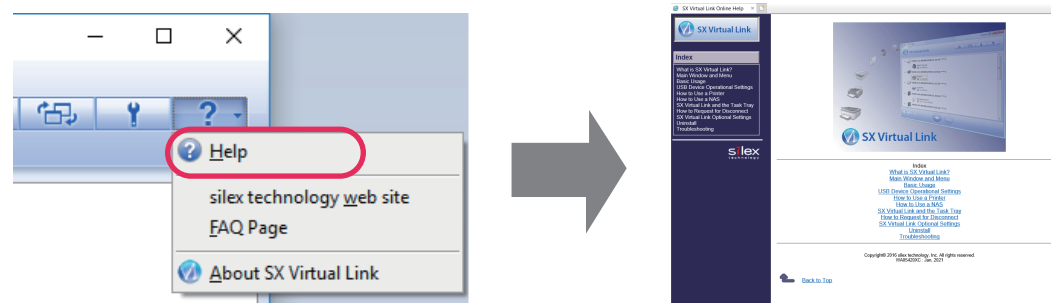

Using the USB devices over the Internet

For how to use the USB device connected to the device server via the Internet, see the user's manual of the device server.

Customer Support Center

If you have any questions, please contact us at the following.

Customer Support Center information

	E-mail
USA	support@silexamerica.com
Europe	support@silexeurope.com

URL: <https://www.silextechnology.com/>